

# Panasonic<sup>®</sup>

## 3DO<sup>™</sup> Interactive Multiplayer<sup>™</sup>

Model No. FZ-10

### Operating Instructions

# 3DO REAL<sup>™</sup>

3DO INTERACTIVE MULTIPLAYER



(Digital audio CD)

(CD-G)

Please read these instructions completely before operating this product.

3DO, the 3DO logos, and Interactive Multiplayer are trademarks of The 3DO Company.

Panasonic is a registered trademark and REAL is a trademark of Matsushita Electric Industrial Co., Ltd  
Photo CD mark licensed from Kodak.

# Precautions and Warnings

Please be sure to read through this instruction manual and completely follow all the written procedures before using the multiplayer.

The following mark and symbols are located on bottom of the product

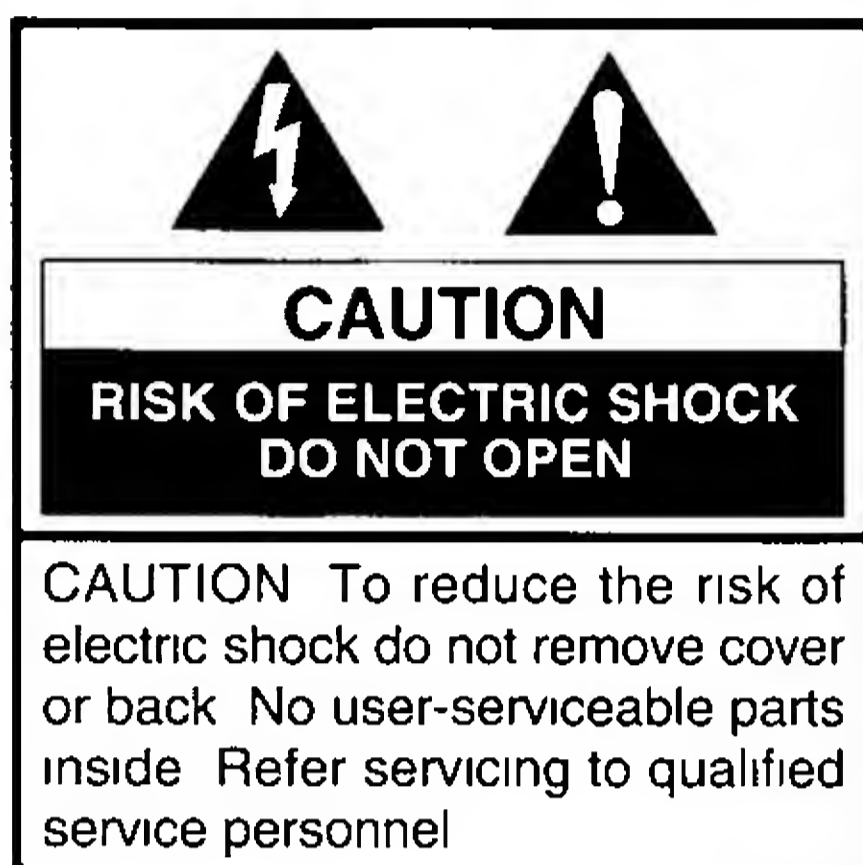

The lightning flash with arrowhead symbol, within an equilateral triangle, is intended to alert the user to presence of uninsulated "dangerous voltage" within the product's enclosure that may be of sufficient magnitude to constitute a risk of electric shock to persons



The exclamation point within an equilateral triangle is intended to alert the user to the presence of important operating and maintenance (servicing) instructions in the literature accompanying the product

"Warnings" and "Cautions" are also included to indicate the need for take special care. Please do not discard these important instructions

## WARNING

To reduce the risk of fire or electric shock, do not expose this product to rain, moisture, or any type of liquid

## Installation

### Placement

In order to prevent injuries or unit damage, do not place the unit on top of an unstable TV set (cart, table, etc.) where it would be prone to fall. Place it on a flat, level surface

### Environment

Do not use or store the unit in locations exposed to heat, direct sunlight, extreme cold, high humidity, excessive smoke, or dust. The unit should be situated away from equipment or devices that generate strong magnetism

### Wall or Ceiling Mounting

The unit should not be mounted on a wall or ceiling

### Water and Moisture

Do not use this unit near water - for example, near a bath tub, wash bowl, in a wet basement, swimming pool, etc. Do not handle this unit or compact discs with wet hands

### Heat

The unit should be situated away from heat sources such as radiators, heat registers, stoves, or other products (including amplifiers) that produce heat

Operating 10°C to 35°C ( 50°F to 95°F )

Storage -20°C to 60°C ( -4°F to 140°F )

When packed for shipment

### Ventilation

Ventilation openings are provided in this unit to prevent overheating. These openings must not be blocked or covered. Do not use this unit directly against a wall, on top of a bed or sofa or in any other place where heat generated will be confined inside the unit

### Stacking

Do not place heavy objects (TV, etc.) on top of the unit. Never allow anyone to stand or sit on this unit



## Transporting

This unit is a precision-made device. Take care to protect it from vibration and impact while moving it. In particular, care must be taken when moving the unit together with a cart, or it may topple over. If the unit is moved suddenly from a cold to a warm location, water vapor may condense in this unit. To correct this problem, turn on the power and wait about one hour for the moisture to evaporate. Always remove a disc before moving the console.

## Attachments

When connecting attachments (control pad, etc.), use only those authorized products that display the 3DO compatibility symbol.

## Note to CATV system installer

This reminder is provided to call the CATV system installer's attention to Section 820-40 of the NEC (National Electrical Code) which provides guidelines for proper grounding and, in particular, specifies that the cable ground shall be connected to the grounding system of the building, as close to the point of cable entry as practical.

## Safety

### Object and Liquid Entry

Never push objects of any kind into this unit through openings as they may touch dangerous voltage points or short-out parts that could result in a fire or electric shock. Never spill liquid of any kind on the unit.

### Power Sources

This unit should be operated only from the type of power source indicated on the unit surface. If you are not sure of the type of power supply to your home, consult your product dealer or local power company.

### Polarization

This unit is equipped with a polarized alternating-current line plug (a plug having one blade wider than the other). This plug will fit into the wall outlet only one way. This is a safety feature. If you are unable to insert the plug fully into the wall outlet, try reversing the plug. If the plug should still fail to fit, contact your electrician to replace your obsolete wall outlet. Do not defeat the safety purpose of the polarized plug.

### Power Cord Protection

Power supply cords should be routed so that they are not likely to be walked on or pinched by items placed on top of or against them, with particular attention paid to cords at plugs, convenience receptacles, and the point where they exit from the unit.

### Outdoor Antenna Grounding

If an outside antenna or cable system is connected to the unit, be sure the antenna or cable system is grounded so as to provide some protection against voltage surges and built-up static charges. Article 810 of the National Electrical Code, ANSI/NFPA 70, provides information with regard to proper grounding of the mast and supporting structure, grounding of the lead-in wire to an antenna discharge unit, size of grounding conductors, location of the antenna-discharge unit, connection to grounding electrodes, and requirements for the grounding electrode. See following diagram.

### NATIONAL ELECTRICAL CODE (NEC)

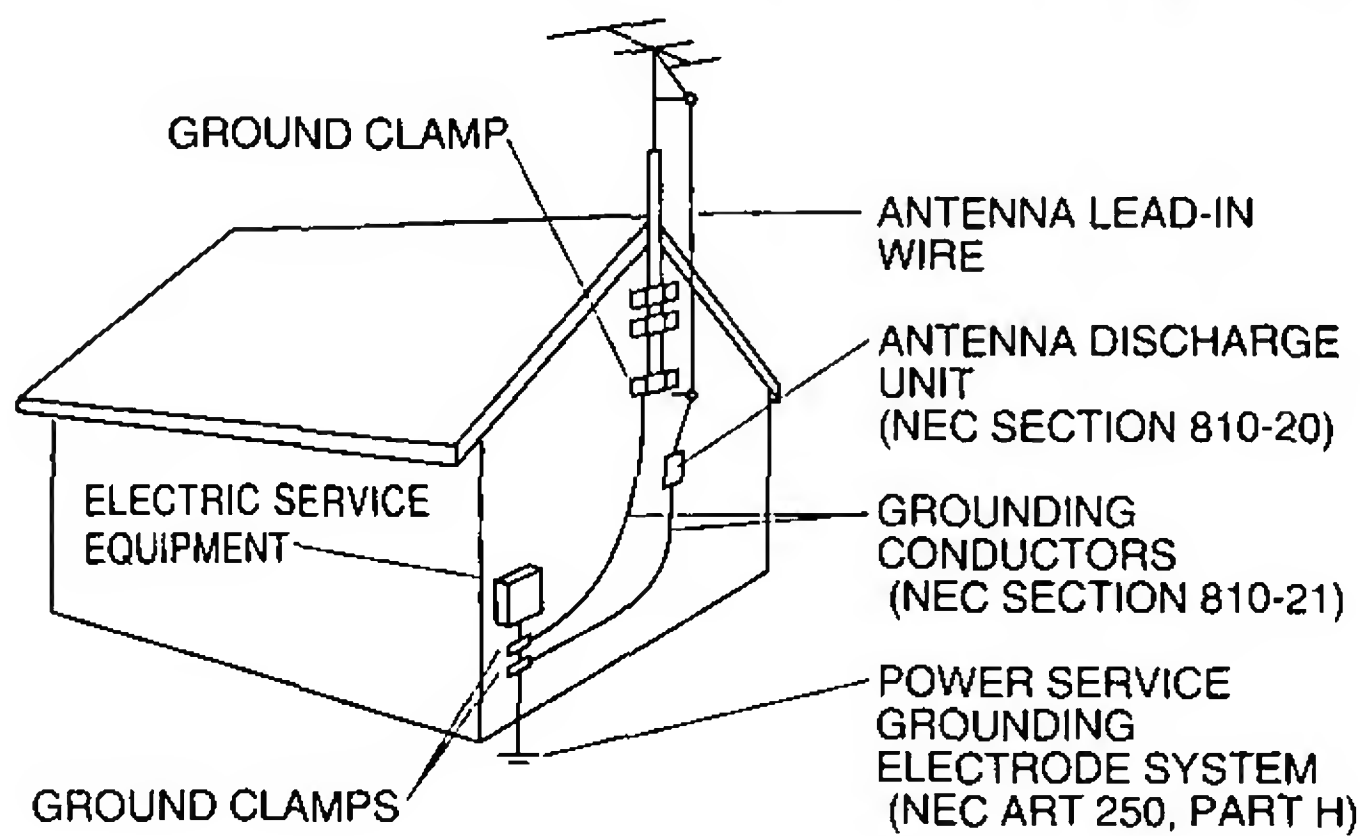

## Lightning

For added protection for this unit during a lightning storm, or when it is left unattended and unused for long periods of time, unplug it from the wall outlet and disconnect the antenna or cable system. This will prevent damage to the unit due to lightning and power-line surges.

## Power lines

An outside antenna system should not be located in the vicinity of overhead power lines or other electric light or power circuits, or where it can fall into such power lines or circuits. When installing an outside antenna system, extreme care should be taken to keep from touching such power lines or circuits, as contact with them might be fatal.

## Overloading

Do not overload wall outlets, extension cords or convenience receptacles, as this can result in a risk of fire or electric shock.

## Cleaning

Unplug this unit from the wall outlet before cleaning. Do not use liquid cleaners or aerosol cleaners. Use a damp cloth for cleaning.

## Maintenance and Service

### Servicing

Do not attempt to service this unit yourself as opening or removing covers may expose you to dangerous voltage or other hazards. Refer all servicing to qualified service personnel.

### Damage Requiring Service

Under the following conditions, unplug this unit from the wall outlet and refer servicing to qualified service personnel:

- a) When the power supply cord or plug is damaged
- b) If liquid has been spilled, or objects have fallen, into the unit
- c) If the unit has been exposed to rain or water
- d) If the unit does not operate normally when following the operating instructions. Adjust only those controls that are described in the operating instructions, as an improper adjustment of other controls may result in

damage and will often require extensive work by a qualified technician to restore the unit to its normal operation.

- e) If the unit has been dropped or damaged in any way
- f) When the unit exhibits a distinct change in performance

### Replacement Parts

When replacement parts are required, be sure the service technician has used replacement parts specified by the manufacturer, or parts which have the same characteristics as the original parts. Unauthorized substitutions may result in fire, electric shock, or other hazards.

### Safety Checks

Upon completion of any service or repairs to this unit, ask the service technician to perform safety checks to determine that the unit is in proper operating condition.

## Control Pad Warning

### Warning

The connection of control pad (or other attachments) to the Interactive Multiplayer console which are not produced under license from The 3DO Company may be hazardous

and result in electrical shock, fire or injury, and could damage the player and/or the unlicensed attachment. Please use caution not to connect any device to the player which does not bear the 3DO logo.

## A caution to projection TV users

To avoid causing damage to the display mechanism of a projection television, do not use the Interactive Multiplayer with this type of television.

Due to the nature of projection television it is advisable to limit the amount of time a frozen or non changing image

is displayed on the screen.

**Panasonic can accept no responsibility for burn-in condition of the display tubes of the projection televisions.**

## Federal communications commission radio frequency interference statement

Note: This equipment has been tested and found to comply with the limits for a Class B digital device, pursuant to Part 15 of the FCC Rules. These limits are designed to provide reasonable protection against harmful interference in a residential installation. This equipment generates, uses and can radiate radio frequency energy and, if not installed and used in accordance with the instructions, may cause harmful interference to radio communications. However, there is no guarantee that interference will not occur in a particular installation. If this equipment does cause harmful interference to radio or television reception, which can be determined by turning the equipment off and on, the user is encouraged to try to correct the interference by one or more of the following measures:

- ❖ Reorient or relocate the receiving antenna.
- ❖ Increase the separation between the equipment and receiver.
- ❖ Connect the equipment into an outlet on a circuit different from that to which the receiver is connected.
- ❖ Consult the dealer or an experienced radio/TV technician for help.

### Warning

To assure continued FCC compliance, the user must use only shielded interfacing cables when connecting to a TV or Accessories, also use the exclusive control pad equipped with shielded cable or shielded cable with ferrite core at end of plug side. Also, any unauthorized changes or modifications to this equipment would void the user's authority to operate.

## CAUTION

THIS PRODUCT UTILIZES A LASER.  
USE OF CONTROLS OR ADJUSTMENTS OR PERFORMANCE OF PROCEDURES OTHER THAN THOSE SPECIFIED HEREIN  
MAY RESULT IN HAZARDOUS RADIATION EXPOSURE.  
DO NOT OPEN COVERS AND DO NOT REPAIR YOURSELF. REFER SERVICING TO QUALIFIED PERSONNEL.  
CLASS 1 LASER PRODUCT:  
THIS PRODUCT CONTAINS A CLASS 1 CD-ROM DRIVE UNIT WHICH COMPLIES WITH DHHS RULES, 21 CFR CHAPTER I,  
SUBCHAPTER J.  
PLEASE ONLY USE TYPE OF CD MENTIONED IN THESE INSTRUCTIONS.

### Warning



## MEDICAL PRECAUTIONS

1. Physical activities involving regular repeated movements of the wrists, hands and/or fingers may possibly cause repetitive strain injury. Such injury may also affect muscles in the arms, wrists, hands, fingers, shoulders and neck, chest and abdomen, and the legs and back.
2. There have been reports that some people may experience epileptic symptoms or even seizures while concentrating on flashing lights. It is possible that persons with no previous epileptic experiences may, nevertheless, have an undetected condition. To avoid a possible medical problem, if you have an epileptic condition, consult your physician before playing video games or any other visually intensive software products.

To avoid either of these situations, and as sound practice, if you should use this product for an extended period of time, it is suggested that you take periodic breaks of 10-15 minutes each hour. Product should be used in a brightly lit room. Operating in a close distance to the TV should be avoided.

In any event, stop using this product and consult your physician if you detect involuntary muscle movements (such as twitching), altered vision, mental or visual confusion, convulsions, muscular pain, numbness of fingers, palms or other areas.

The model number and serial number of this product can be found on bottom of the product. Please note them in the space provided right and retain them for future reference.

MODEL NUMBER: FZ-10

SERIAL NUMBER: \_\_\_\_\_

# Unpacking

Check the packing carton for these items  
If any item is missing, please contact your dealer  
immediately

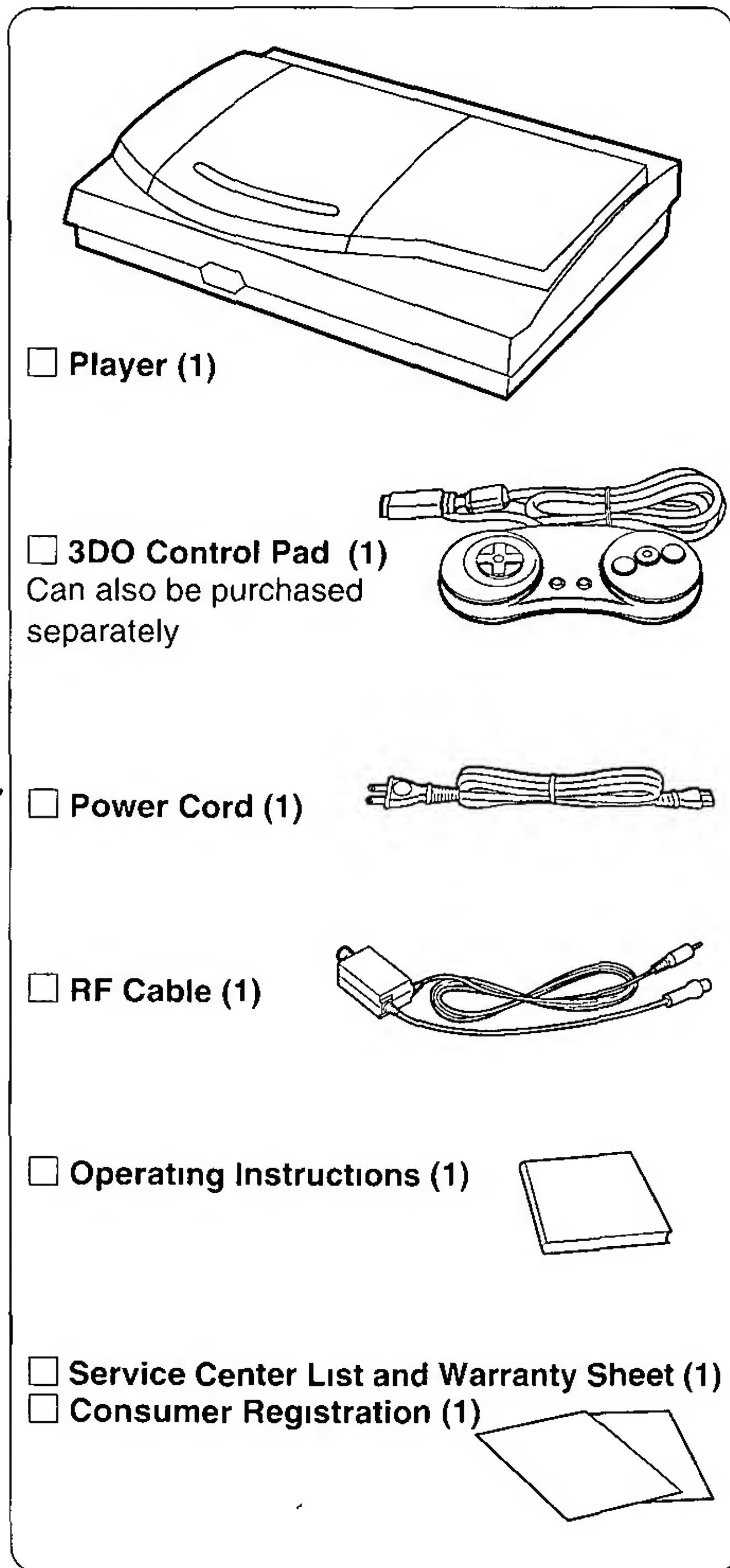

# Contents

## 7 Control pad

## 7 Handling CDs

## 8 Connection

## 10 Basic operation

### 10 Playing games with a 3DO™ CD

## 12 Using Photo CDs

### 12 Viewing photo collections (Photo CDs) on the TV screen

## 14 Using audio CDs and CD-G

### 14 Listening to audio CDs and viewing CD-G

### 16 NORMAL setting

### 16 RANDOM setting

### 17 PROGRAM setting

### 18 Repeat play (REPEAT ON)

### 18 To switch from stereo to monaural or vice versa

## 19 Troubleshooting

## Back cover Specifications

# Control pad

## ■ How to hold the control pad

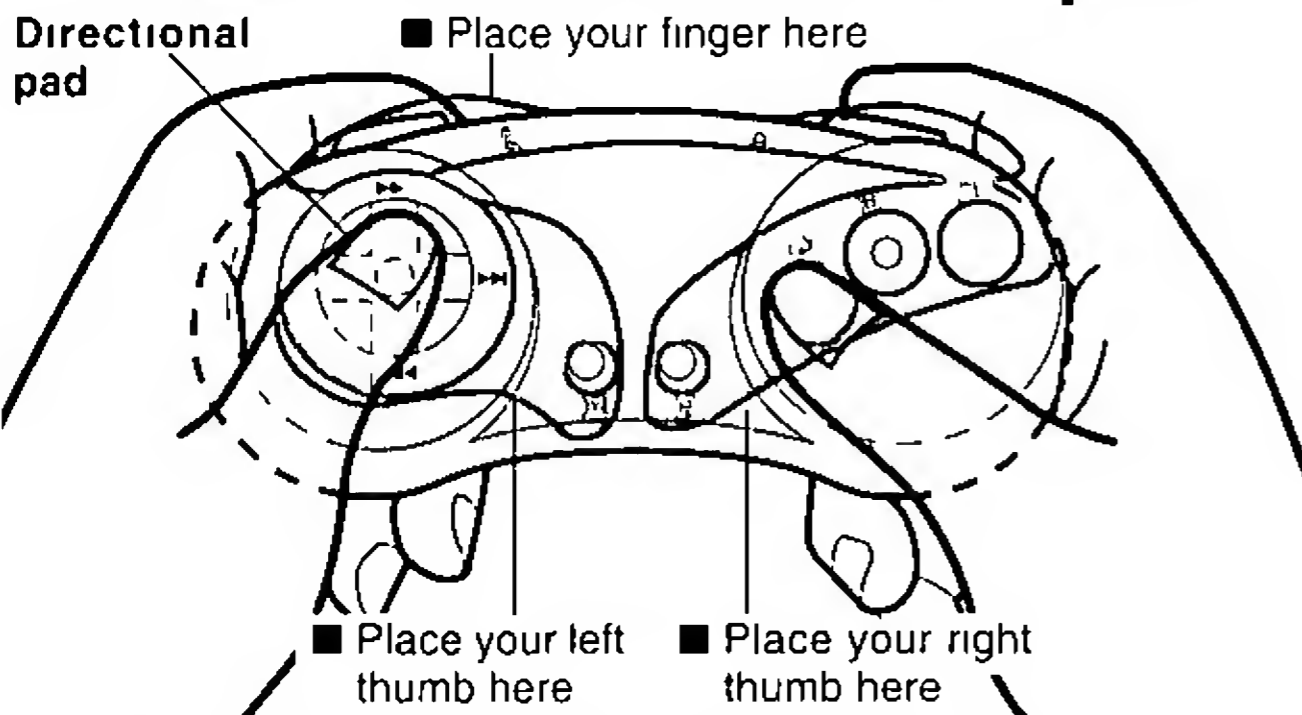

## ■ Details on directional pad and button functions

The functions performed by the directional pad and buttons differ depending on the software used. Refer to the instructions accompanying each software package.

❖ When using 3DO™ control pads made by another manufacturer, follow the instructions accompanying them.

## ■ When connecting two or more control pads

Some software allows the connection of additional control pads so that two or more (up to 8) persons can play together at the same time.

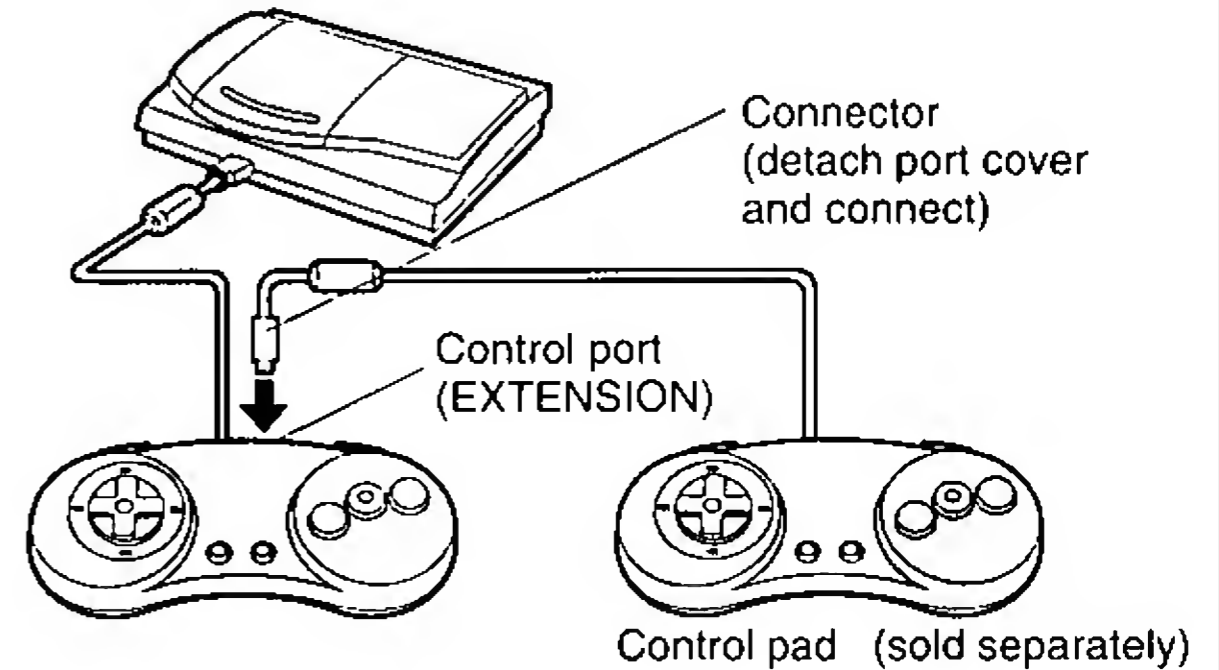

A control pad (model number FZ-JP1X) with a headphone jack can also be used.

# Handling CDs

## ■ How to remove a CD from its case

Press the center holder down and remove.

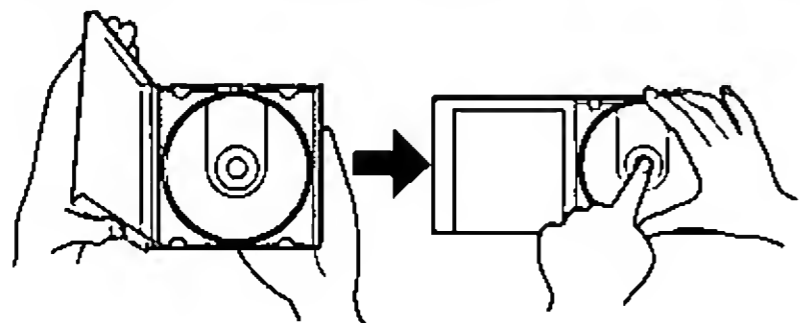

## ■ How to hold a CD

Do not touch the surface of the CD.

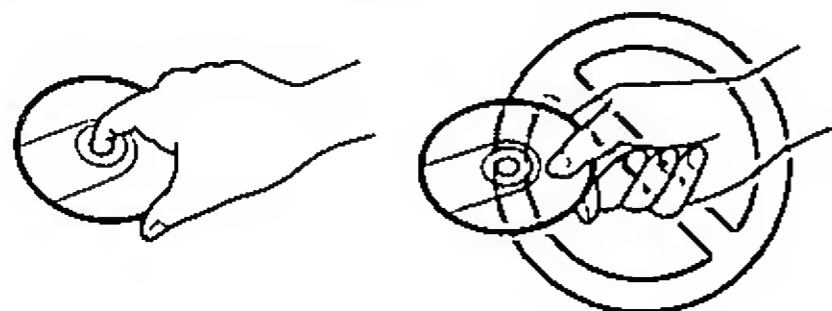

## ■ Precautions

For the label side (with the printing)

- Do not write anything with a pencil or ballpoint pen
- Do not apply any paper, stickers, etc.

For the disc side (shiny side)

- Handle this side carefully so that no fingerprints or marks are left on it
- Do not use a conventional record cleaner or solvent
- Do not use a CD lens cleaner

## ■ How to return a CD to its case

With the label side facing up, press the CD down over the center holder.

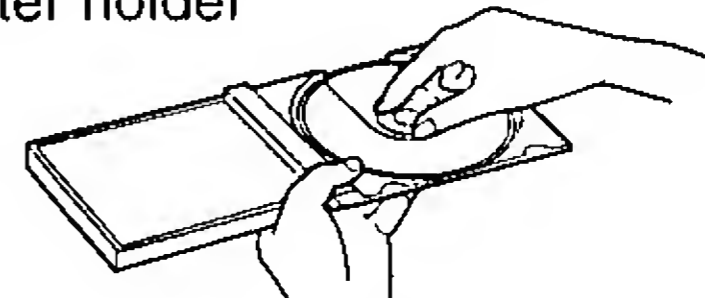

## ■ When a CD is dirty

First wipe the CD with a soft cloth moistened with water and then wipe with a dry cloth. Always wipe from the center of the CD toward its edge.

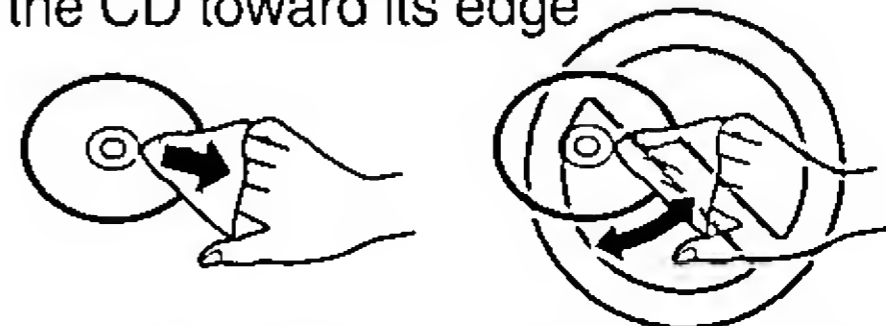

## ■ When condensation has formed

If condensation has formed when a CD has been suddenly brought from a cold environment into a warm room, wipe it off using a soft dry cloth.

## ■ Where to keep or store your CDs

- Anywhere not exposed to direct sunlight
- Anywhere with minimal moisture and dust
- Anywhere not directly exposed to heat from a heater

# Connection

Connecting the player to a TV set (or stereo system, etc.)

## 1 Switch off the TV set.

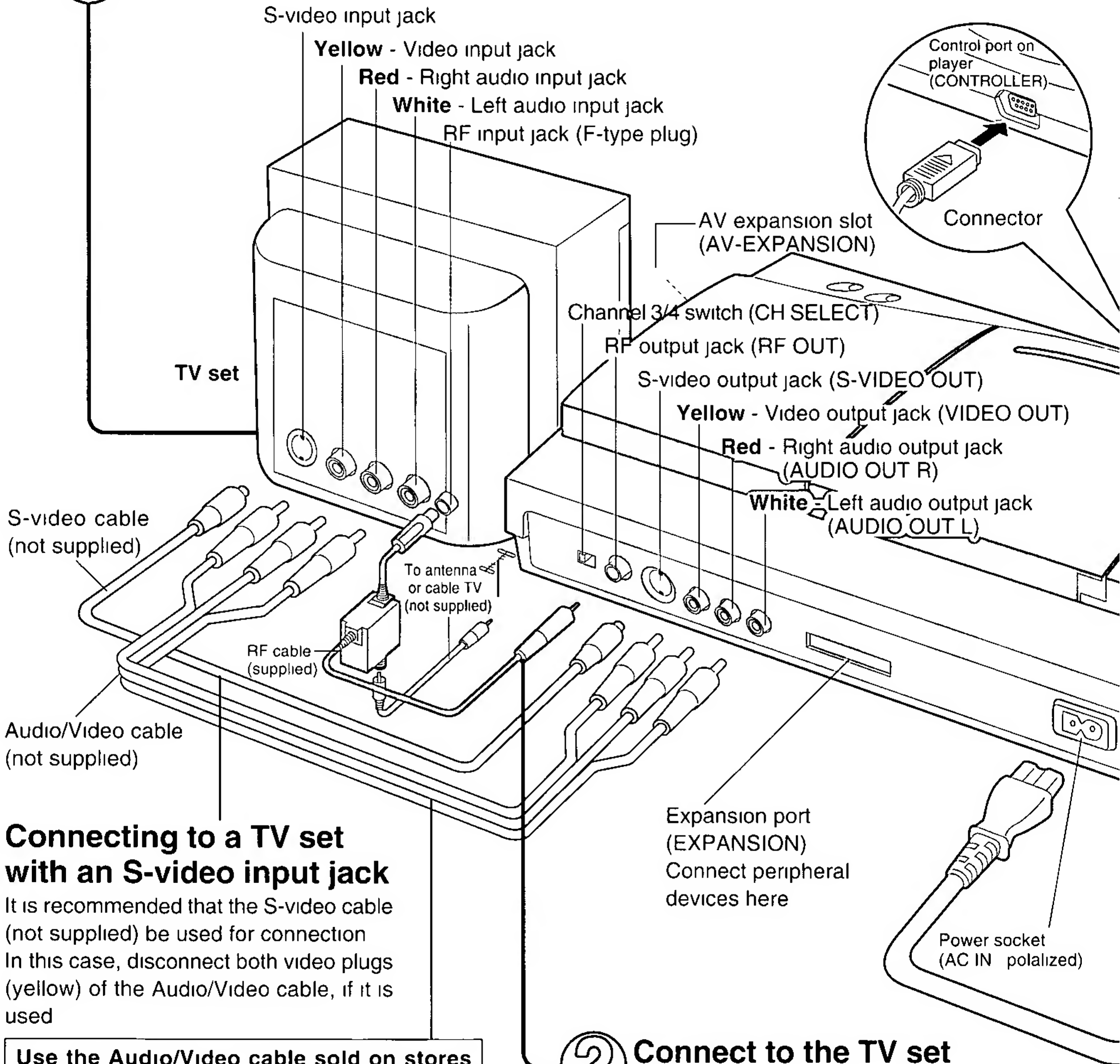

### Connecting to a TV set with an S-video input jack

It is recommended that the S-video cable (not supplied) be used for connection. In this case, disconnect both video plugs (yellow) of the Audio/Video cable, if it is used.

Use the Audio/Video cable sold on stores when connecting with a TV set having audio/video input jacks.

Match up the colors of the jacks and plugs

- ❖ In the case of connection with RF cable, all CDs are played in monaural sound

## 2 Connect to the TV set and Antenna.

Set CH SELECT to the channel not used for broadcasting in your area (3 or 4), using the tip of a ballpoint pen or similar instrument.



**3 Connect the control pad.**

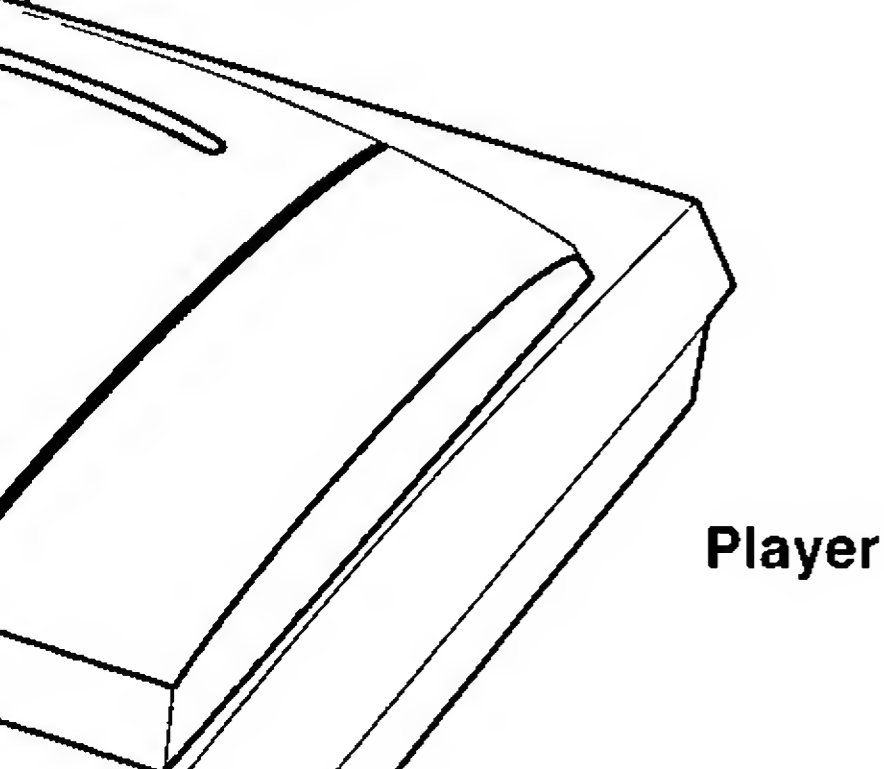
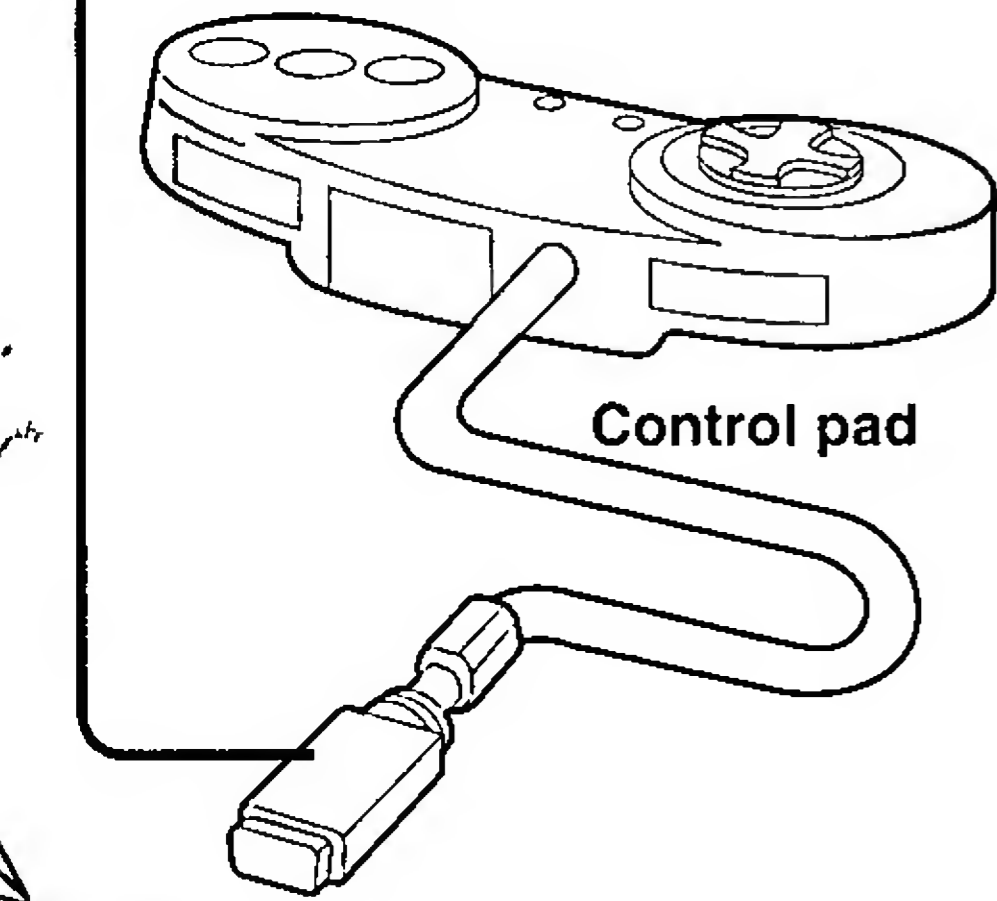

Player

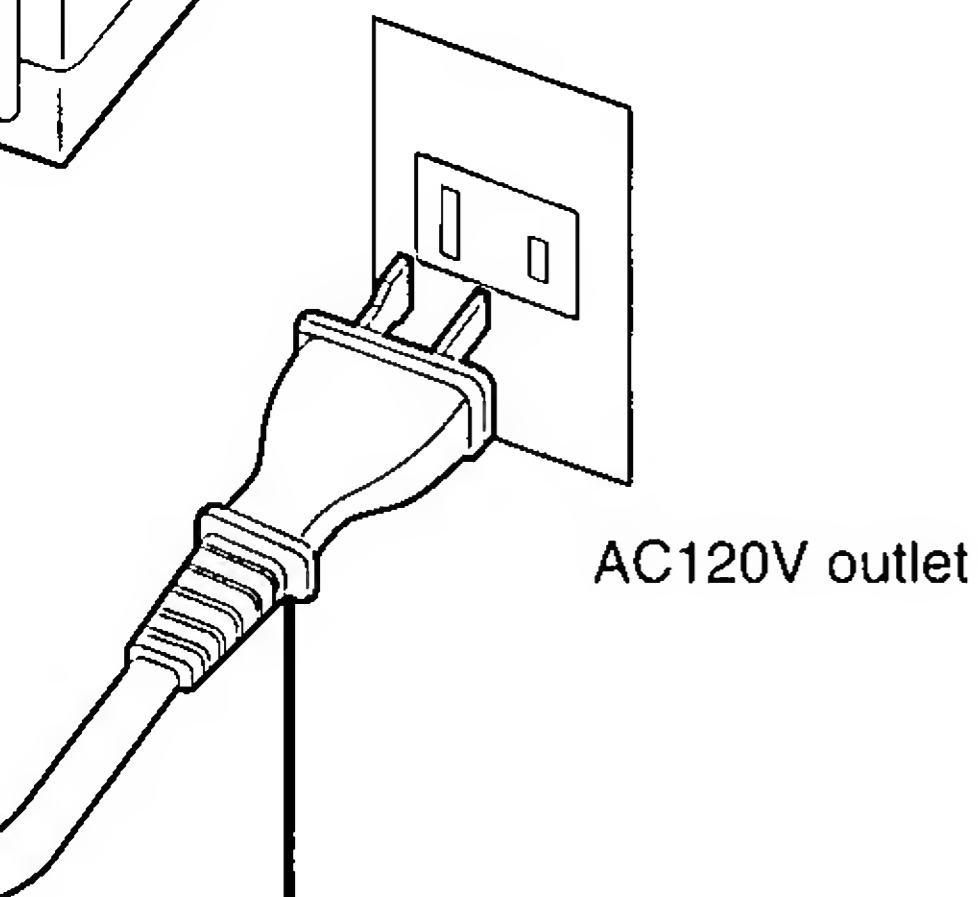

AC120V outlet

**4 Connect the power cord.**

**■ Connection with a TV set**

TV set with "MONO" audio and video input jacks

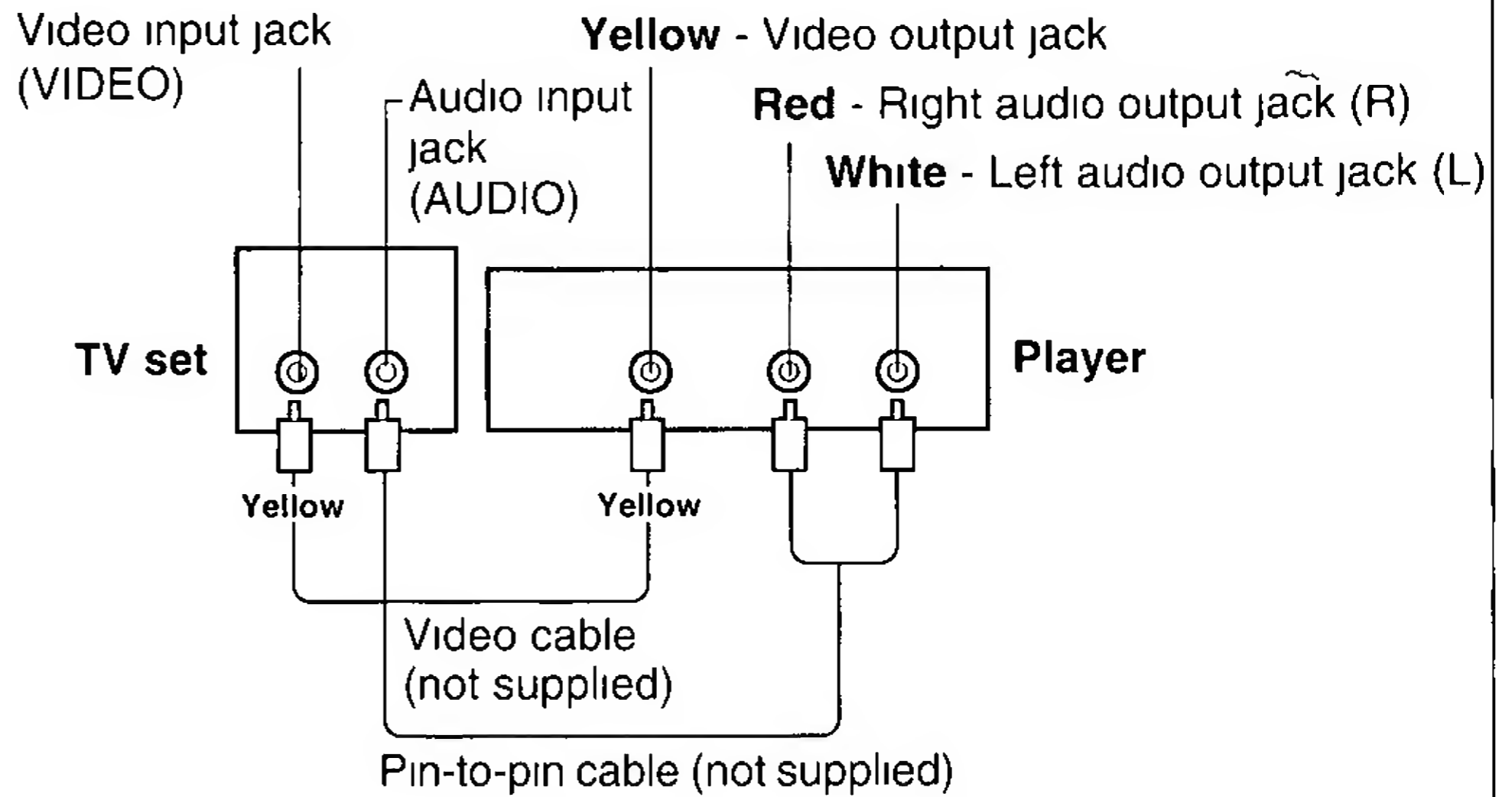

**When a different type of TV set or antenna is used**

Different parts (not supplied) are required depending on the type of TV set or antenna. First check the type of TV set and antenna and then consult with your Audio/Video dealer.

**■ Connection to a TV set and stereo system**

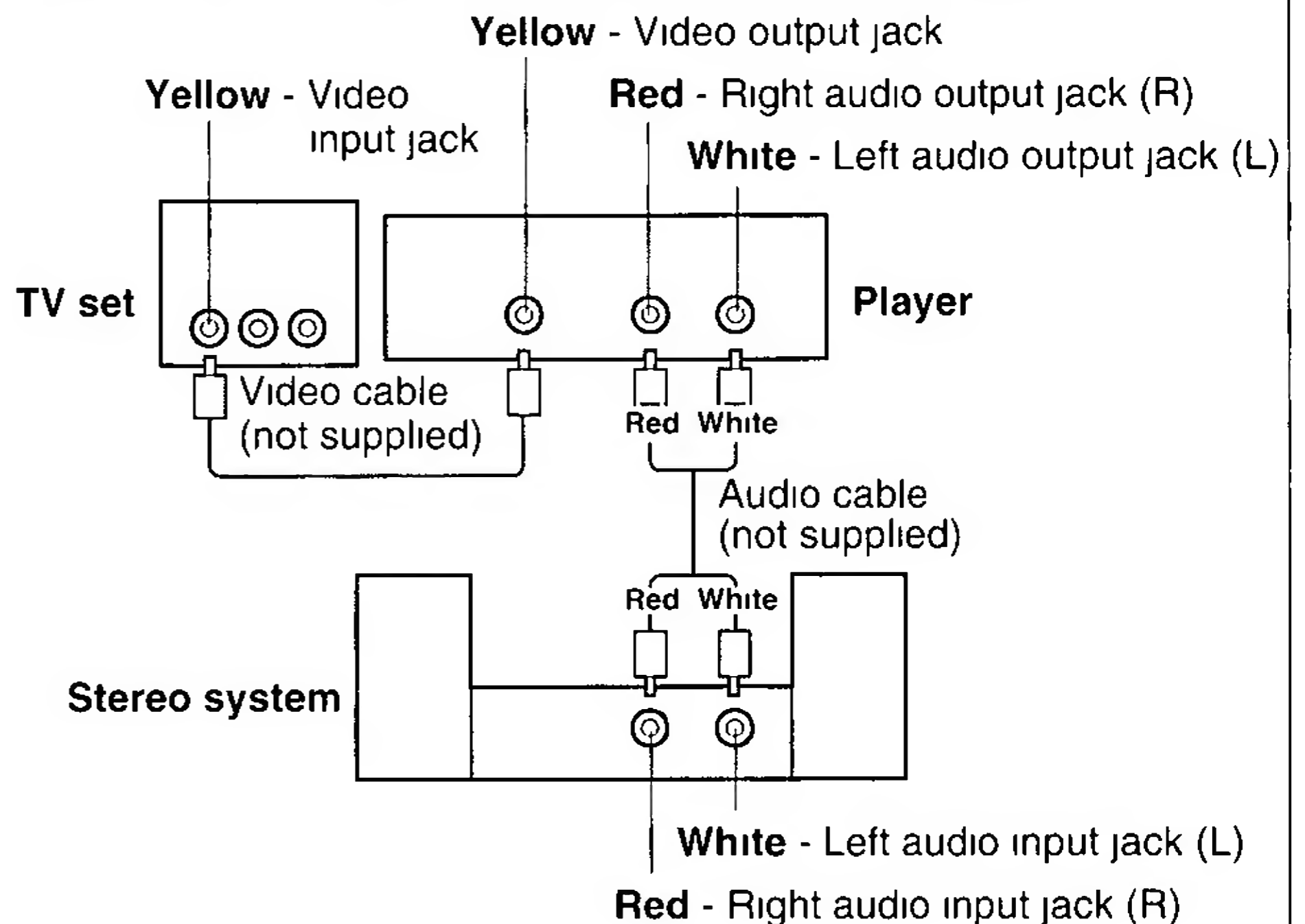

Also refer to the operating instructions accompanying the stereo system.

# Basic operation

## Playing games with a 3DO™ CD

- ① **Switch on the TV set,**  
and set to the channel to which  
the player has been connected

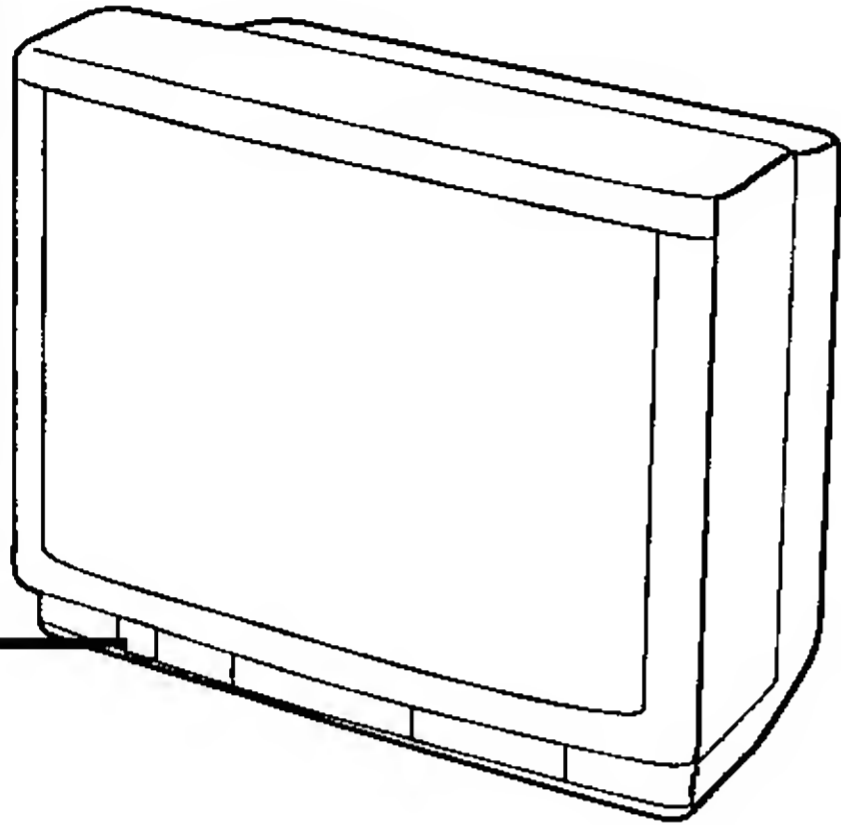

- ② **Set the power switch (POWER) to ON.**  
The ready indicator (READY) lights up red

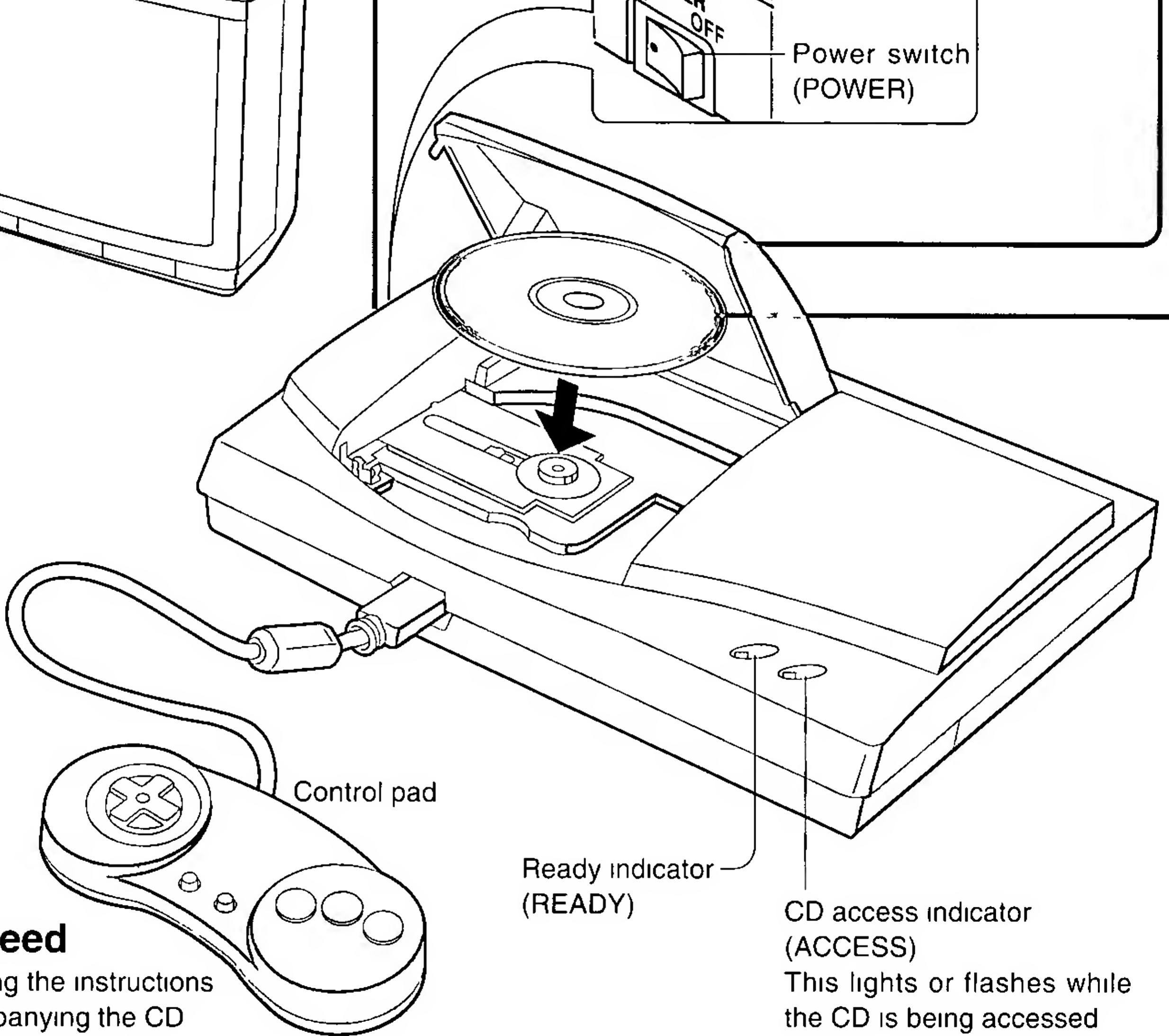
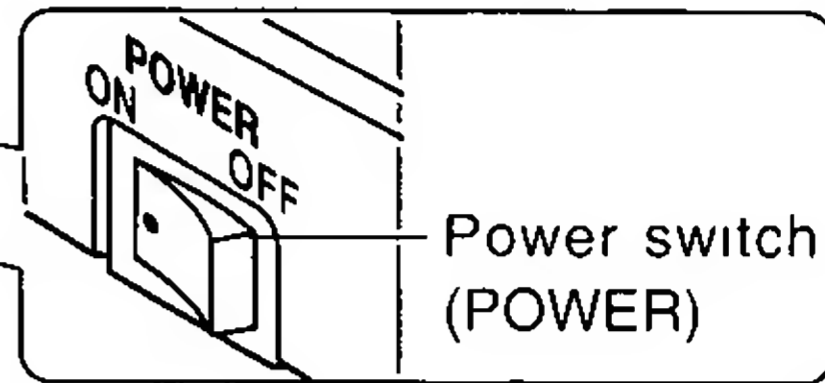

- ⑥ **Proceed**  
following the instructions  
accompanying the CD  
software in use

### ■ How to quit

- ① Quit the software being used (Refer to the instructions accompanying the software used)
- ② Open the lid
- ③ Remove the CD once it has stopped spinning
- ④ Close the lid
- ⑤ Set the power switch (POWER) to OFF

### Removing the CD

Put your finger on the center holder while raising one side of the CD with your thumb  
**Don't press down hard the center holder**

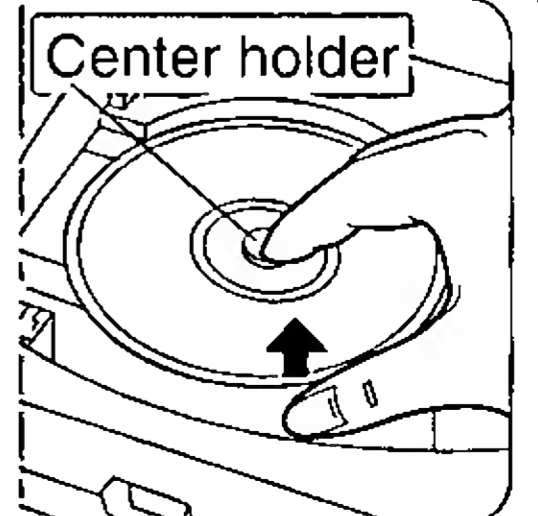

- 3** Press [PUSH] to open the lid.

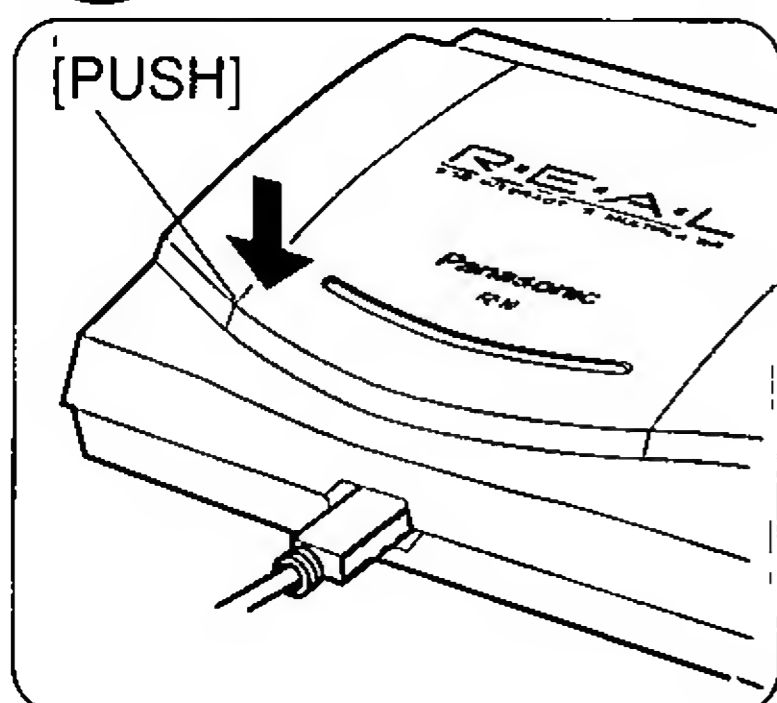

- 4** Insert the CD. Insert the CD with its label side facing up

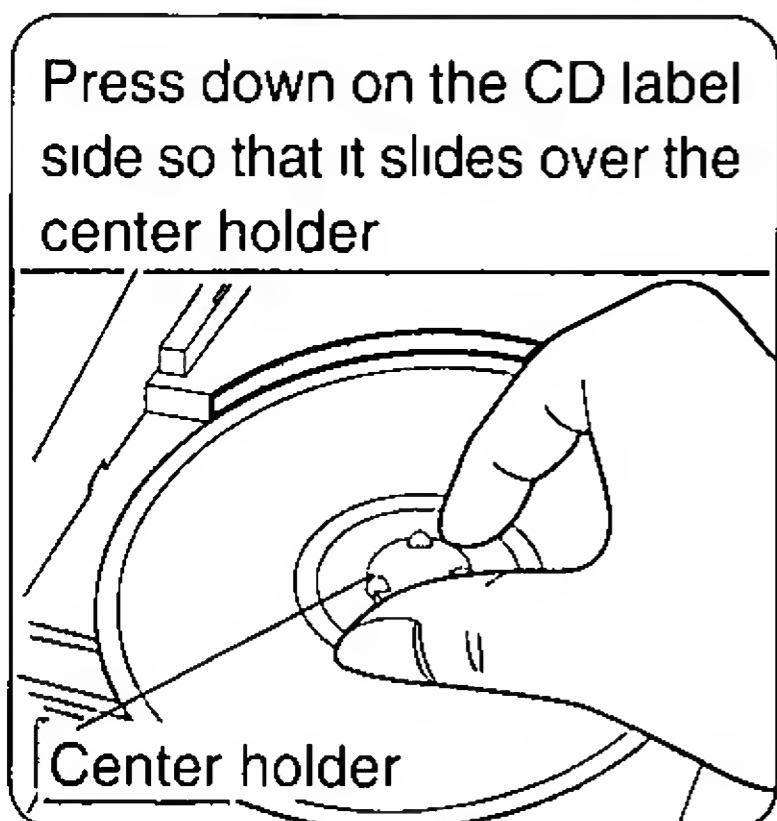

- 5** Press [PUSH] to close the lid until it clicks. With a 3DO™ CD The game now starts automatically

**Caution**

- If the CD has not been properly placed on the center holder, it may be damaged when the lid is closed
- The sound of CD drive accessing may be heard when operating software. This is not a malfunction

**How to use the STORAGE MANAGER**

**Game data can be saved.**

Depending on the game software, it may be possible to save results and other such data at interim stages in the built-in storage. The saved data will not be lost even when the power is turned off. (For details on operation, refer to the instructions accompanying the software concerned.)

**Saved data can be removed.**

When the built-in storage is full, no more new data can be saved. In this case, it is possible to remove data no longer required by following the procedure given below:

- 1 Without inserting a CD in the player, turn on the power
- 2 When the "Press X to start STORAGE MANAGER" message appears, press the X button. (The data list screen now appears.)
- 3 Select the item to be removed using the up/down directional pad

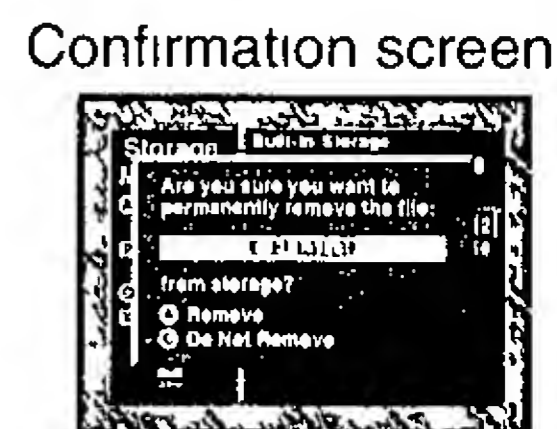
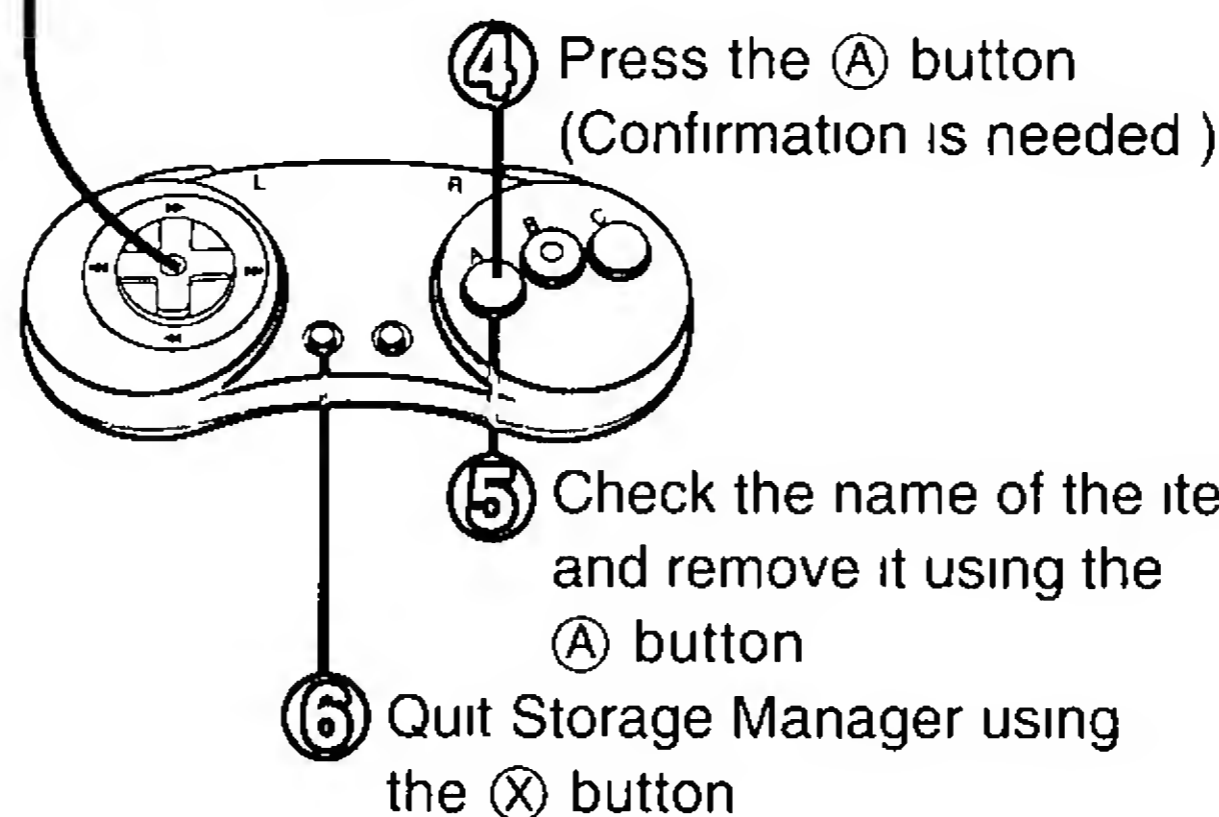

Press the P button to remove all the item

**Data names**

- When a name is too long to be viewed on the list screen, check it on the confirmation screen
- All track sequences of audio CDs (see page 17) are stored in "acd playlist". This is listed as "Audio CD Program" on the list screen

**Caution**

- Always press the X button when the list screen is displayed to quit Storage Manager. If the power is turned off or the lid is opened or closed before quitting Storage Manager, the contents of the back-up memory may be lost
- The numbers on the list screen denote the amount of data in the back-up memory. Included in these numbers are the 64 bytes used by the system. "Total memory size" denotes the total memory in use. The system uses 152 bytes at all times
- Once removed, data cannot be restored!

# Using Photo CDs

## Viewing photo collections (Photo CDs) on the TV screen

Important or valuable photographs can be stored semi-permanently in a CD album where they will not be subject to discoloration. Up to 100 photos can be stored on a CD and viewed on a TV's large screen.

### How to create a Photo CD

Take your 35 mm films to a camera store which handles Photo CDs  
(For details, consult a camera store which is qualified to handle Photo CDs)

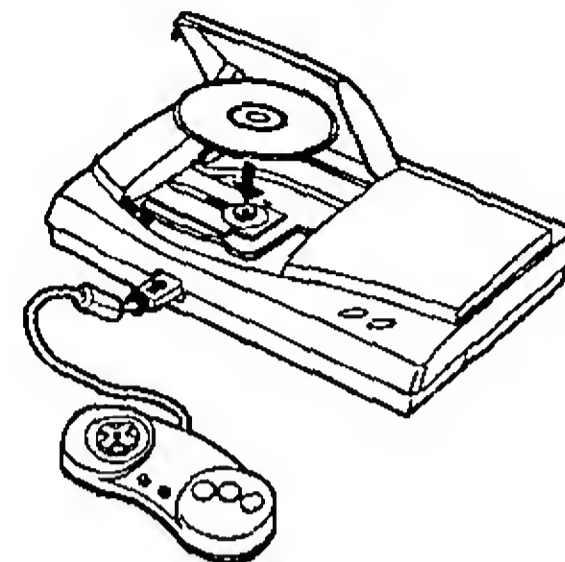

### Directional pad

#### Panning up/down or to the left/right

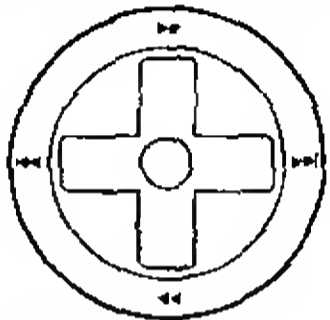

The photo is panned up or down or to the left or right, depending on which direction the pad is pressed

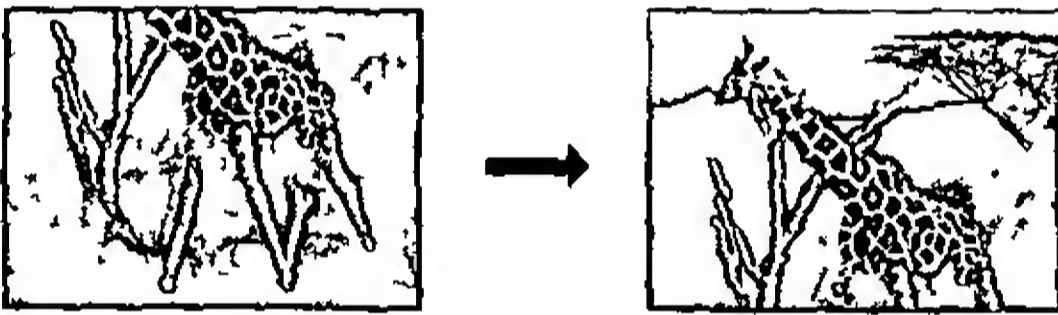

#### Rotate function

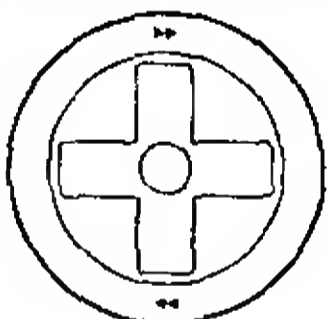

The photo is rotated when the up/down directional pad is used while the L (or R) button is held down

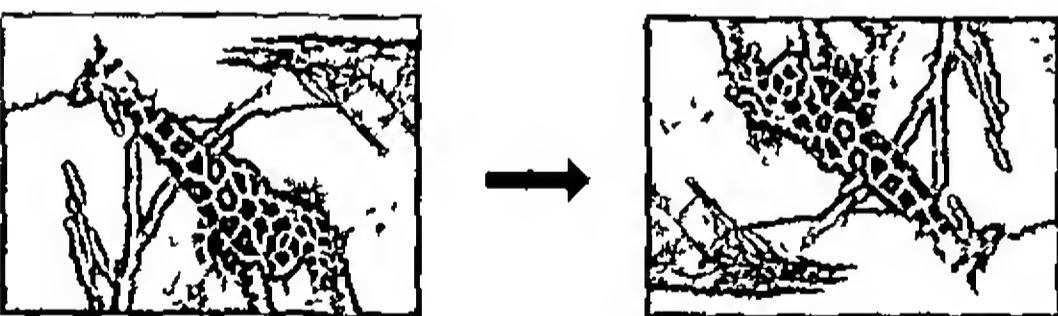

#### Mirror function

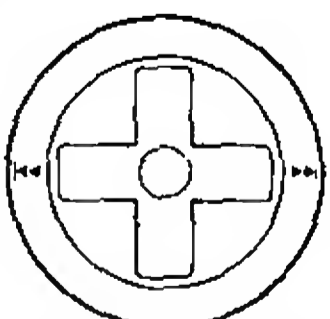

A mirror image of the photo is displayed if the left/right directional pad is operated while the L (or R) button is held down

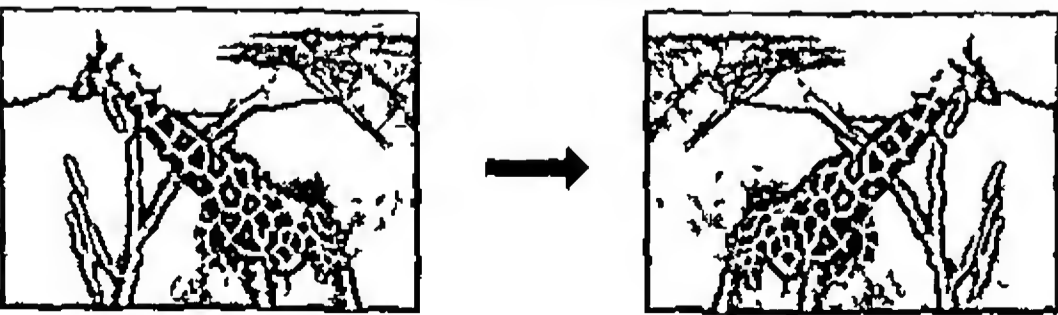



- First, insert a CD bearing this logo. The total number of photos on the CD is now indicated, and the first photo is then displayed

**To automatically flip through photos or stop this**

**To display the photo number**

Press the L (or R) and P buttons (Press the buttons again to remove this number)

**To return to the first photo**

Use the L button together with another button or the directional pad

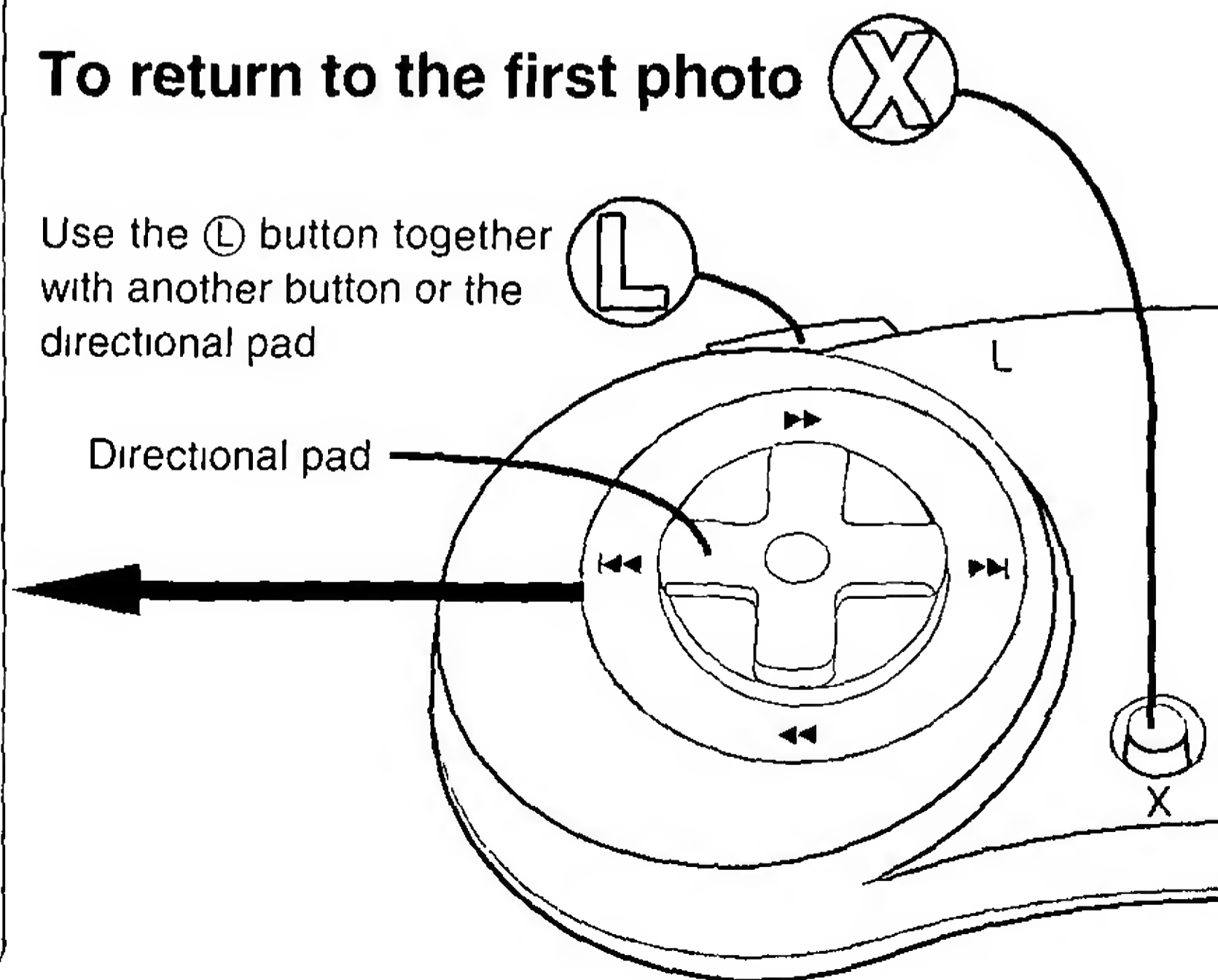

**A**

**To view the next photo:** Press **A** button

**To view the previous photo:** Press down either **L** or **R** button and then press **A** button

### To flip through photos

Hold the **A** button down and the photos will flip forward

To go backwards, hold down either the **L** or **R** button and then press the **A** button until you reach the photo you want to see again

**B**

### To use the zoom function

Each time the **B** button is pressed, the zoom box changes, zooming commences when it is pressed while the **L** (or **R**) button is held down

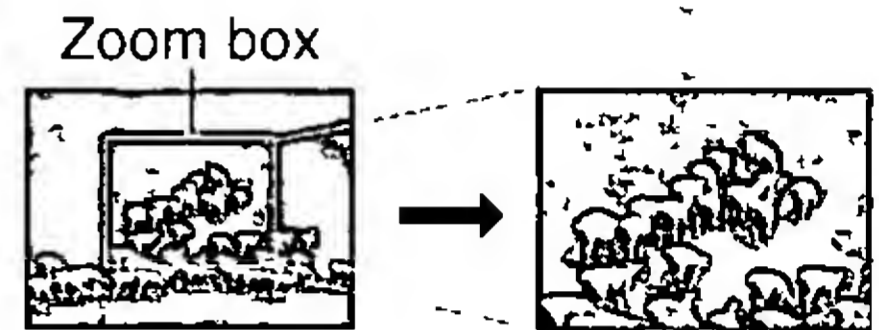

### To set the photo display to half size

When there is no box, press the **L** (or **R**) and **B** buttons (When the buttons are pressed again, the display returns to normal size)

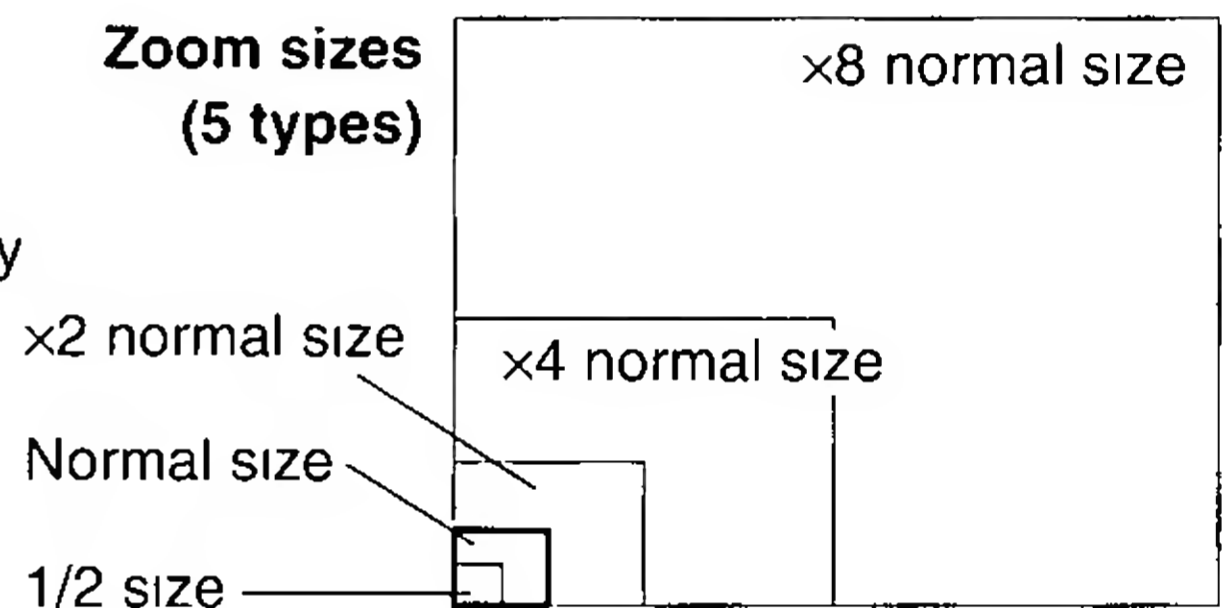

**R**

Use the **R** button together with another button or the directional pad

**C**

### To view the control pad HELP screen

(The screen appears only while the button is pressed)



### Up/down or left/right panning speed

This speed can be adjusted by pressing the **L** (or **R**) and **C** buttons together



### How to quit

Press [PUSH] on the player to open the lid. Remove the CD once it has stopped spinning

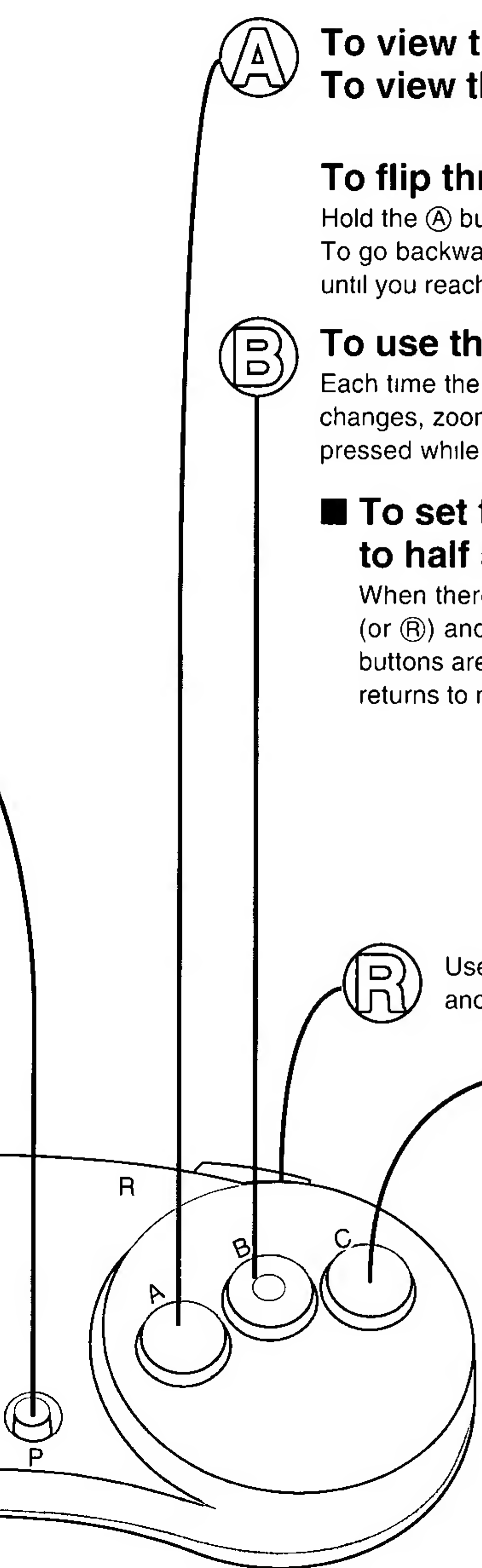

# Using audio CDs and CD-G

## Listening to audio CDs and viewing CD-G

Audio CDs and CD graphics containing still pictures can be used



- First, insert a CD bearing one of these logos  
(For details on inserting the CD, see page 11)



To play or pause (▶/⏸)



To stop play (■)



### Directional pad

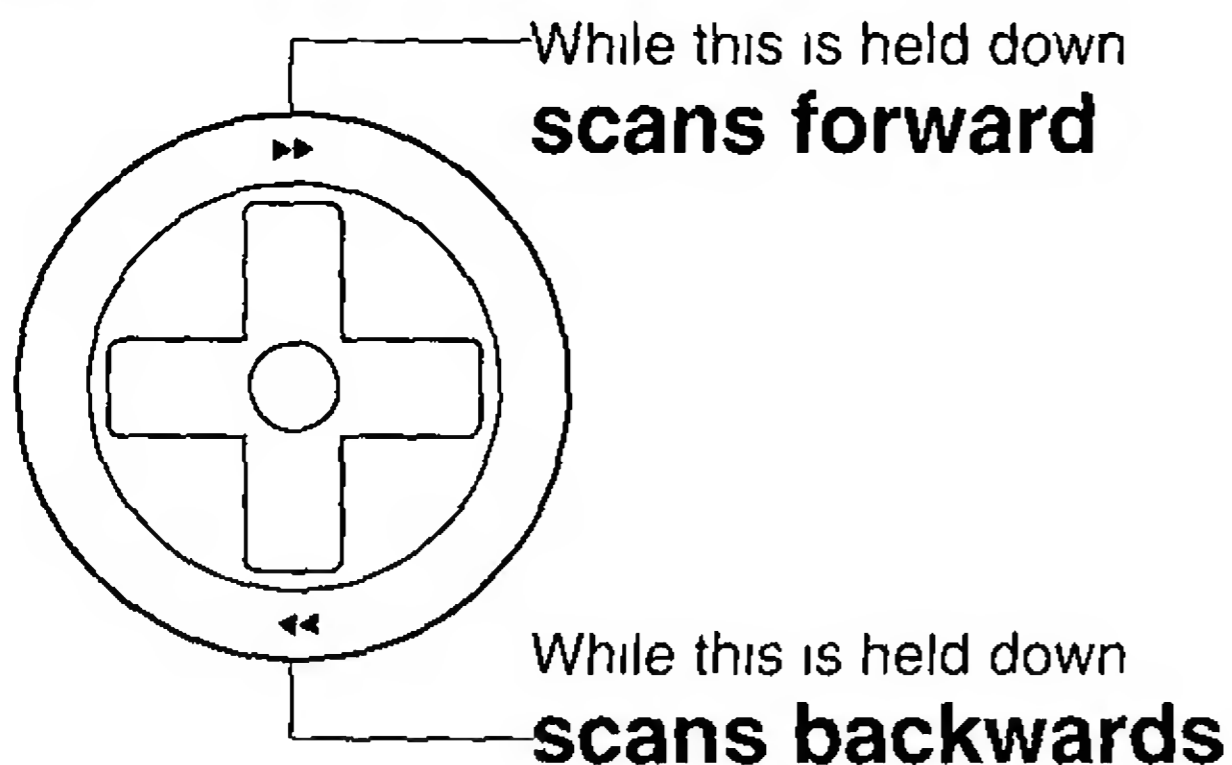

To change the track play sequence

Use this button together with the X button (See pages 16 and 17)



Directional pad

L

When pressed a number of times **skips back** a track for each time pressed

When pressed a number of times **skips forward** a track for each time pressed

If this is pressed once during play, play will return to the start of the current track

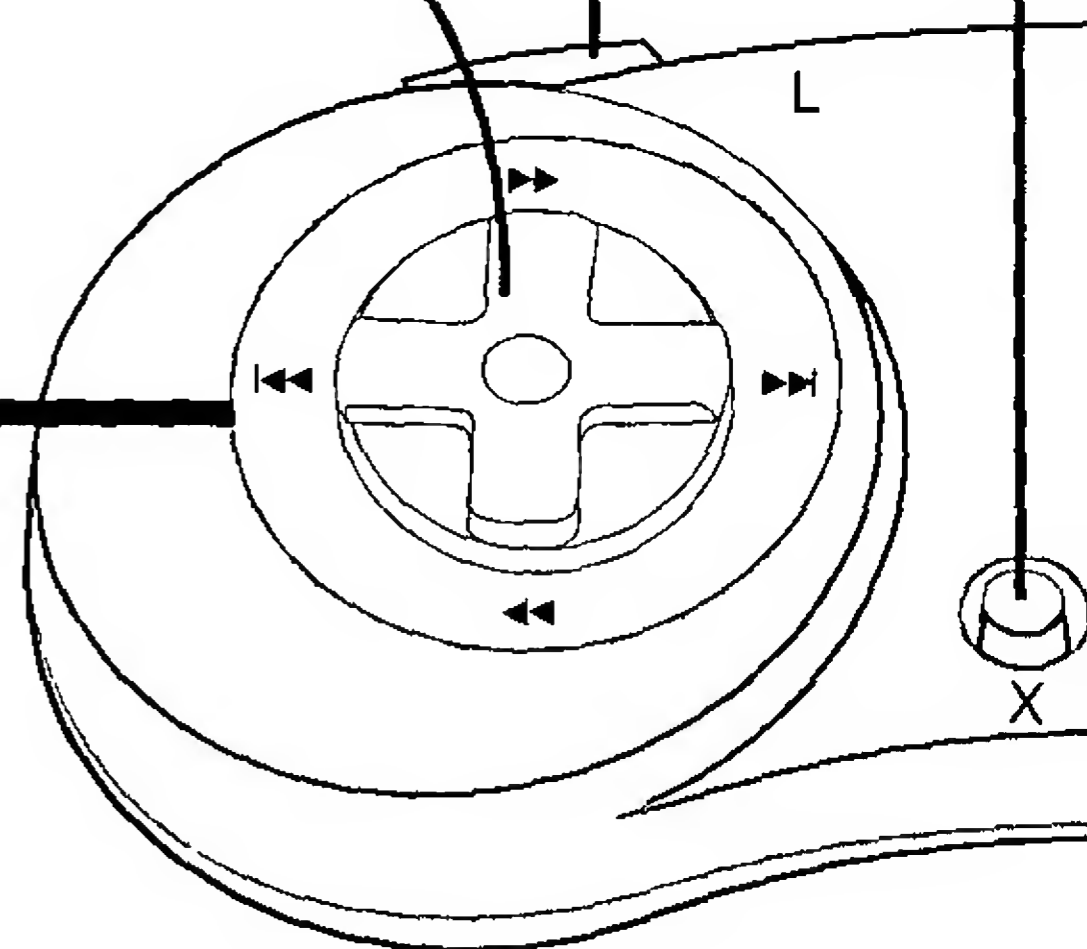

**A** To set the image screen where graphics dance to the rhythm

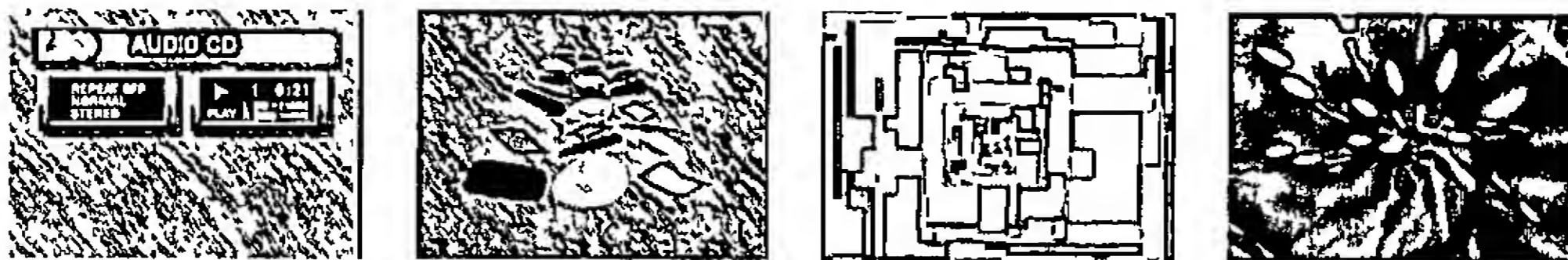

(This player contains four screens Any screen can be viewed while the CDs are being played )

**B** To switch screens during CD-G play  
(Only for CD-G with multiple screens)

**R** To change the track play sequence

Press this button together with the ⊗ button  
(See pages 16 and 17 )

**C** To view the control pad  
**HELP** screen

(The screen appears only while the button is pressed )

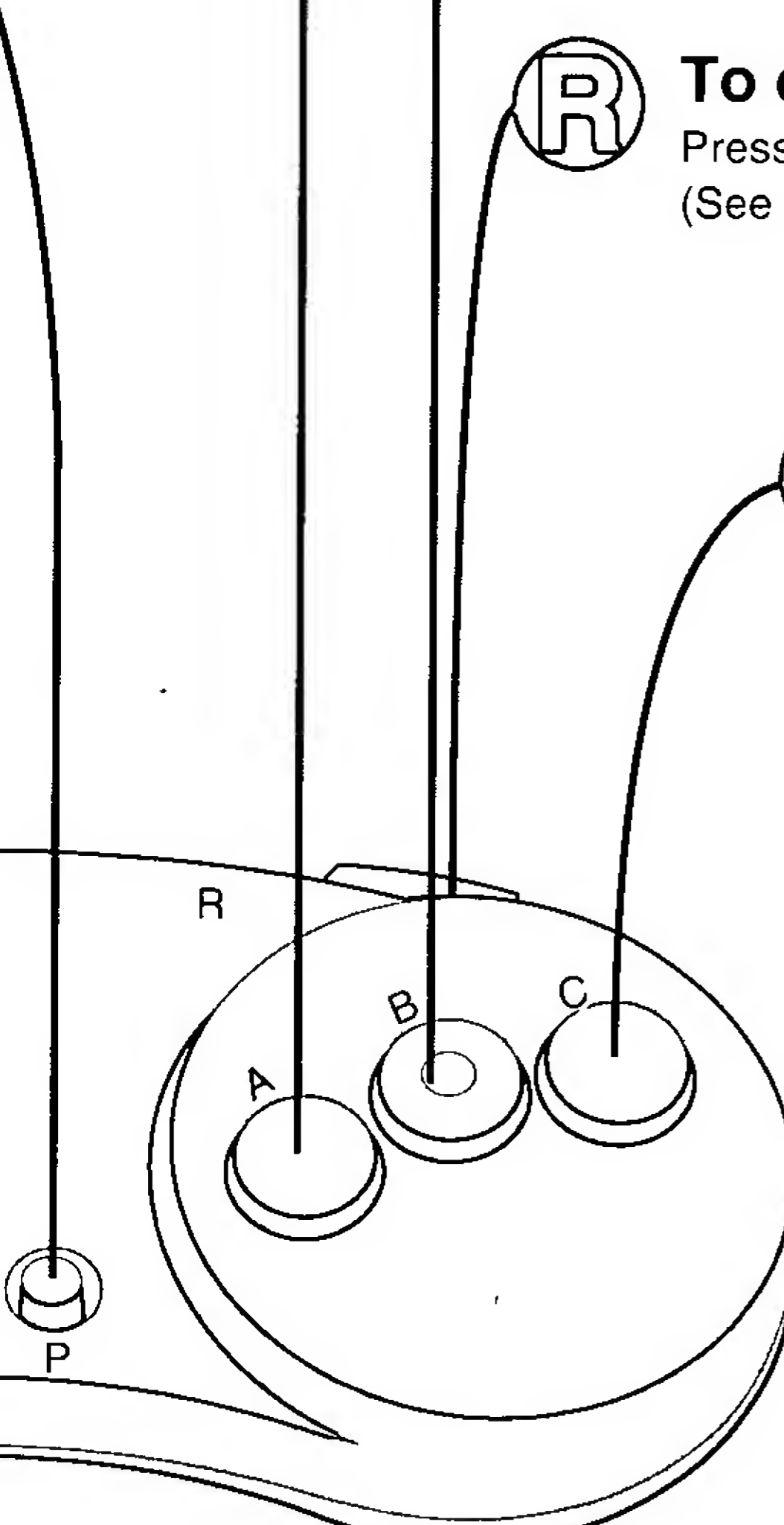

■ **How to adjust the volume**

Adjust the volume to the desired level using the controls on the TV set or stereo system

■ **How to quit**

Press [PUSH] on the player to open the lid Remove the CD once it has stopped spinning

**Caution**

The images may be disturbed if any operations (such as scan) are done during CD-G play sequence

# Using audio CDs and CD-G

## NORMAL setting for listening to tracks from the beginning

All the tracks starting with the first track are heard.

Press the **P** button  
(Play now begins)

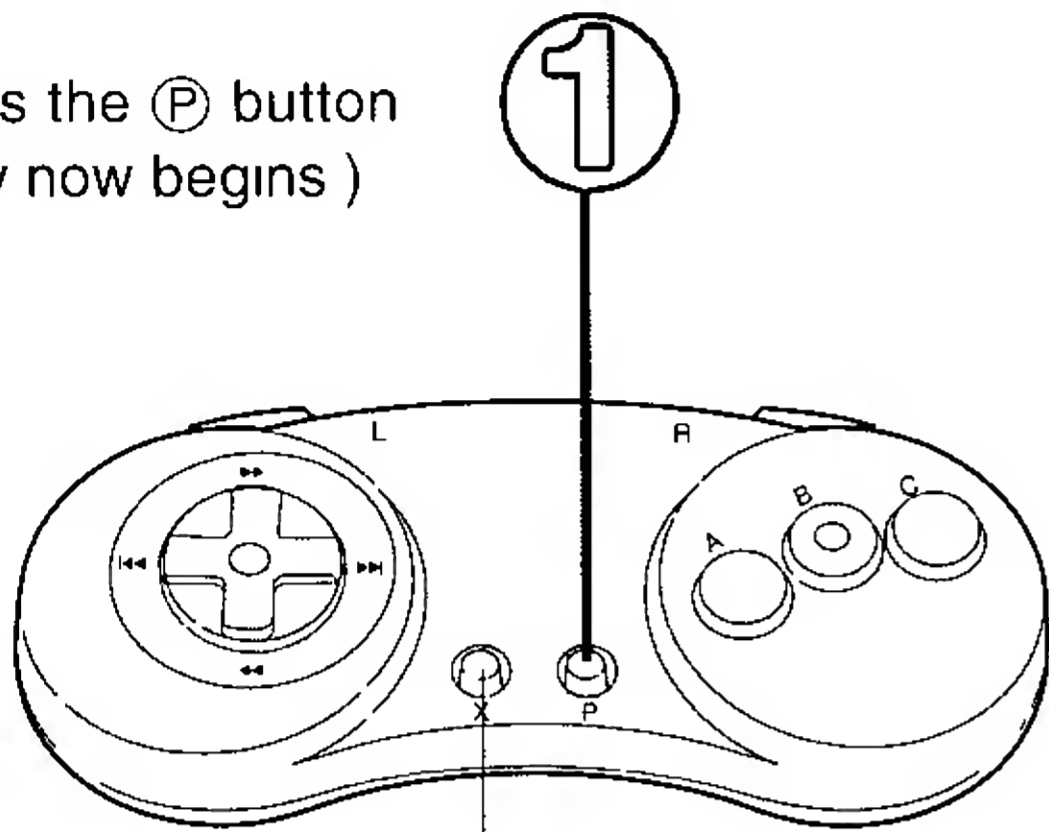

■ **To stop play**

Press the **X** button

Play screen



Track number

Elapsed play time

Audio level

■ **To find out the number of tracks or total play time**

Display the programming screen by pressing the **L** (or **R**) and **X** buttons

Programming screen

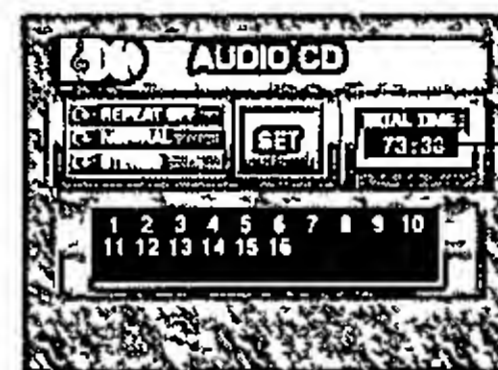

Total play time

Press the buttons again to return to the play screen

## RANDOM setting for listening to the tracks in random order

With this setting the player decides the sequence in which it will play the tracks. (It does this automatically)

Programming screen

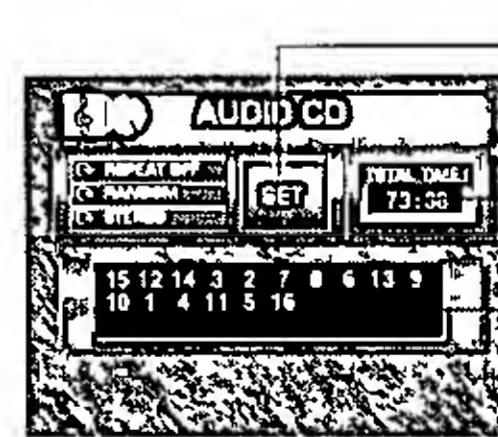

SET

Total play time

Track sequence

1 Display the screen shown on the right by pressing the **L** (or **R**) and **X** buttons

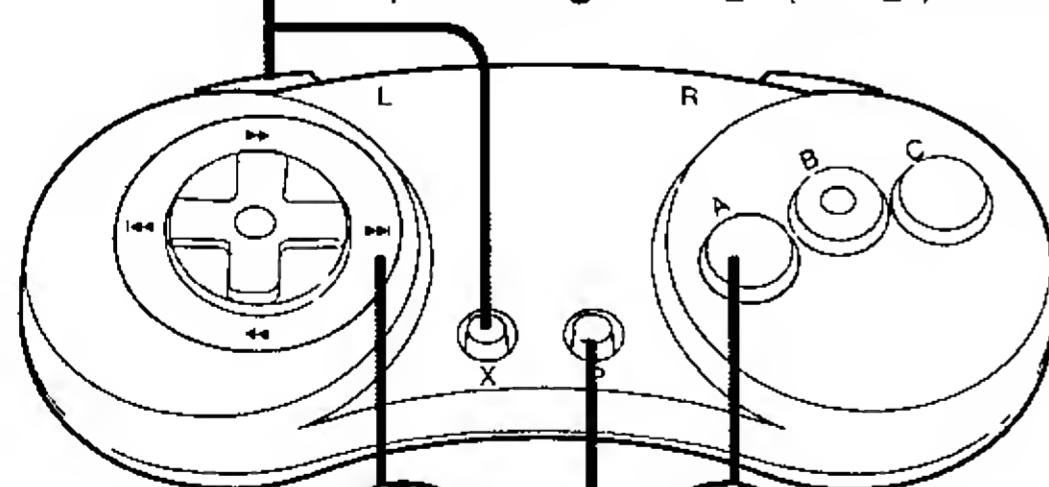

2 Select NORMAL using the up/down directional pad

2

3 Select RANDOM using the **A** button

3

4 Select SET using the left/right directional pad

4

5 Return to the play screen using the **A** button

5

6 Press the **P** button (Play now commences)

6

### Caution

The tracks will be played at the RANDOM setting from now on

A CD which was last played in the RANDOM mode will be played at the RANDOM setting when it is next played

This setting needs to be reset to return to the NORMAL setting if the CD is to be played starting from the first track

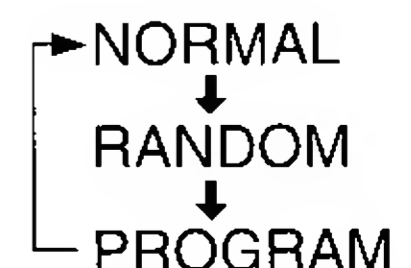



## PROGRAM setting for listening to selected tracks only

Selected tracks are heard in their programmed sequence.

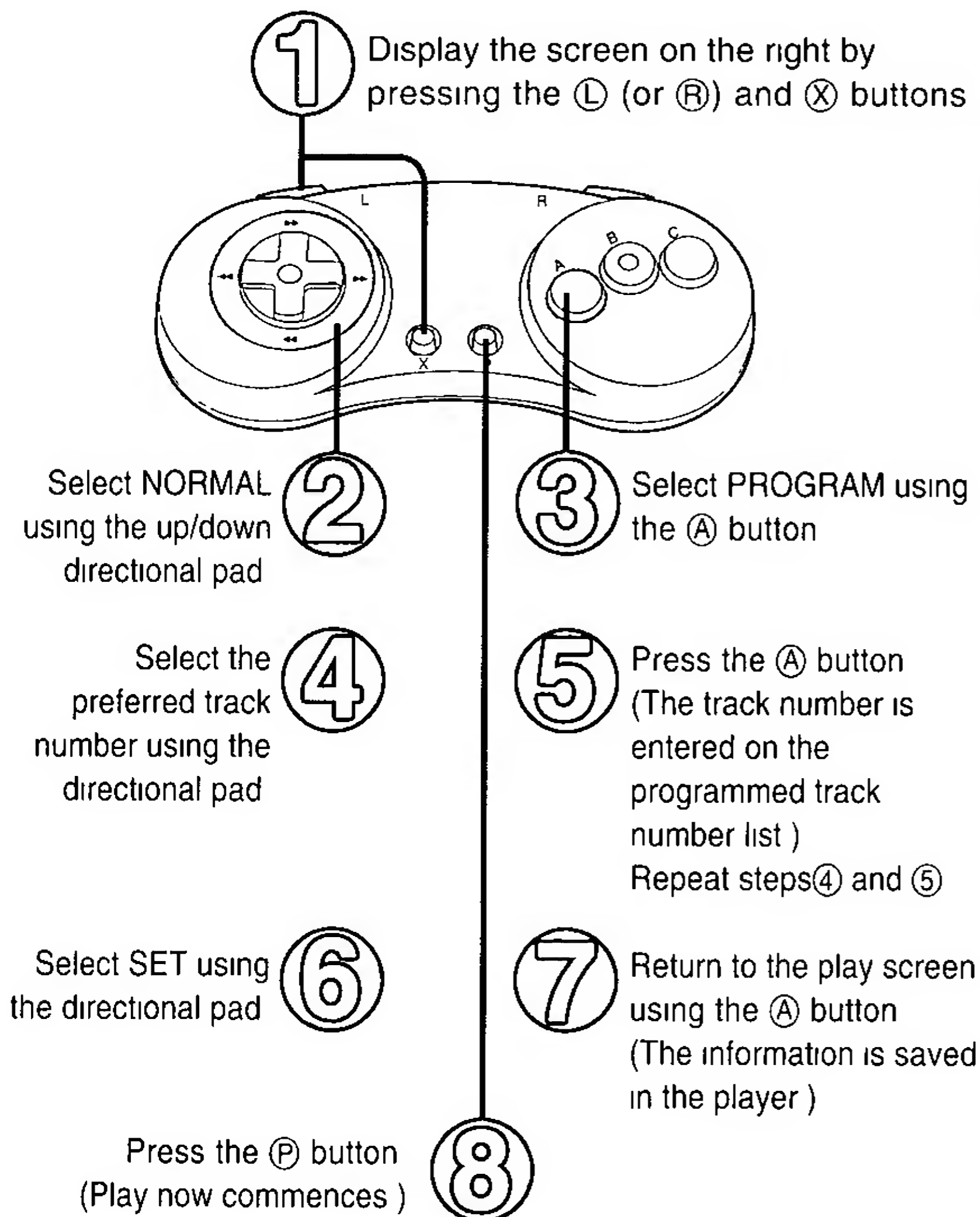

Programming screen

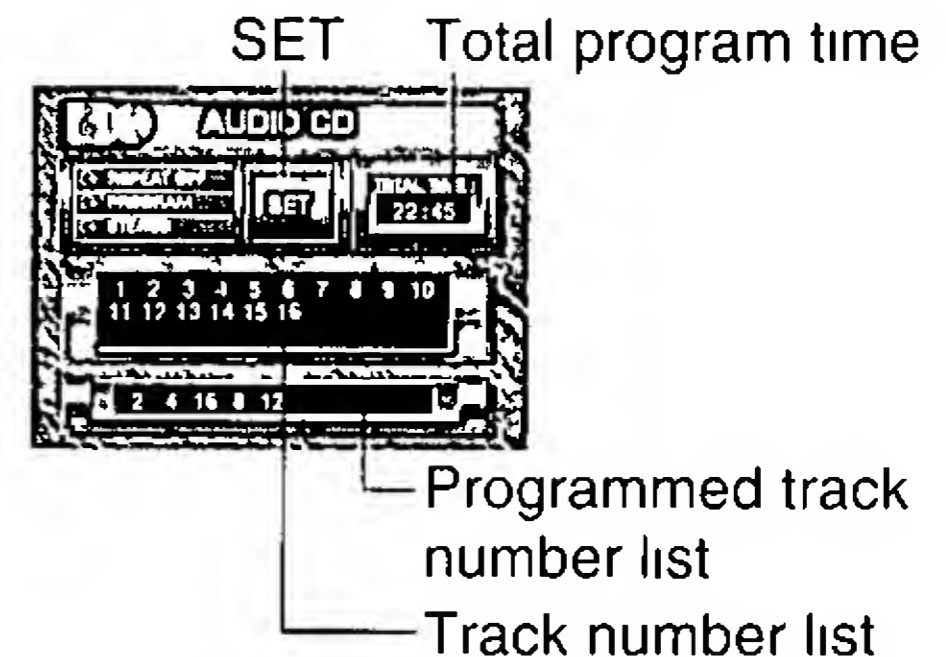

### ■ To delete a programmed track

Use the directional pad to select the number of the track to be deleted from the programmed track number list, and press the (A) button

### ■ To add another track

Use the directional pad to select the position in the programmed track number list where the track is to be added

Use the directional pad to select the number of the track to be added from the track number list

Press the (A) button

## Track sequences for about 80 audio CDs can be saved.

Simply by inserting the same CD, it is possible to listen to the tracks in their saved sequence

### Caution

- In some cases, a track sequence can not be saved  
A sequence can not be saved when the amount of game data saved is too large In this case, remove data which is no longer required (See page 11 )  
However, when even one sequence has been saved,  
Memory for about 80 CDs is set aside so that it is not affected by the amount of game data stored
- When the memory size for saving track sequences (equivalent to about 80 CDs) has been exceeded, Track sequences are automatically erased, starting from the oldest ones, and new track sequences are stored

## ■ Repeat play (REPEAT ON)

- 1 Switch to the programming screen by pressing the (L) (or (R)) and (X) buttons
- 2 Select REPEAT OFF using the up/down directional pad
- 3 Set REPEAT ON using the (A) button
- 4 Select SET using the left/right directional pad
- 5 Return to the play screen using the (A) button

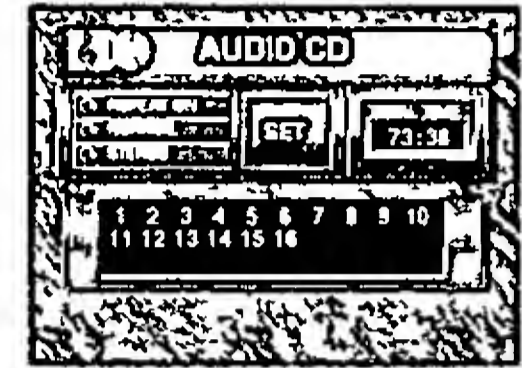

## ■ To switch from stereo to "MONO" or vice versa

- When using a sound-multiplexed CD for "karaoke" such as CD-G (when the singer's voice is heard through the right channel and the accompaniment through the left)
- When the sound mode is set to R-MONO or MONO, you can listen to the example singing first, or when the sound mode is set to L-MONO you can sing along to just the accompaniment

- 1 Display the programming screen by pressing the (L) (or (R)) and (X) buttons
- 2 Select STEREO using the up/down directional pad
- 3 Decide on one of the settings on the right using the (A) button
- 4 Select SET using the left/right directional pad
- 5 Return to the play screen using the (A) button

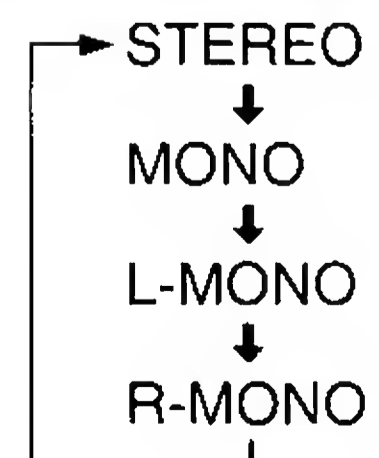

# Troubleshooting

Please check through the items listed below before requesting repair service

Symptom	Checkpoint	Reference page No.
<b>No power.</b>	<ul style="list-style-type: none"> <li>• Has the power cord been plugged in properly?</li> </ul>	<b>9</b>
<b>No picture.</b>	<ul style="list-style-type: none"> <li>• Have the player and TV set been turned on?</li> </ul>	<b>10</b>
	<ul style="list-style-type: none"> <li>• Have the player and TV set been connected properly?</li> </ul>	<b>8</b>
	<ul style="list-style-type: none"> <li>• Is the TV/VCR selector set to the correct position?</li> </ul>	<b>10</b>
<b>No further operation is possible.</b>	<ul style="list-style-type: none"> <li>• Set the power switch (POWER) to OFF and reset the power switch to ON</li> </ul>	—
<b>No CD play.</b>	<ul style="list-style-type: none"> <li>• Has the CD been set properly over the center holder?</li> </ul>	<b>11</b>
	<ul style="list-style-type: none"> <li>• Has the CD been inserted with its label side facing up?</li> </ul>	<b>11</b>
	<ul style="list-style-type: none"> <li>• A CD which is not compatible with the player can not be used</li> </ul>	Front cover
	<ul style="list-style-type: none"> <li>• The CD is dirty → Wipe off the dirt using a soft cloth</li> </ul>	<b>7</b>
	<ul style="list-style-type: none"> <li>• The lens is dirty → Wipe off the dirt using a cotton swab or blow it away using a rubber blower for cleaning lenses (available from camera stores)</li> </ul>	—
	<ul style="list-style-type: none"> <li>• Is the CD scratched, cracked, or warped? (If so, do not use it )</li> </ul>	—
	<ul style="list-style-type: none"> <li>• Has condensation formed on the player? → Turn off the power, wait an hour or so for the condensation to dry out, and then try operating the player</li> </ul>	—
<b>Demonstration screen appears but no further operation is possible.</b>	<ul style="list-style-type: none"> <li>• Has a CD been inserted?</li> </ul>	<b>11</b>
	<ul style="list-style-type: none"> <li>• Has the CD been inserted properly over the center holder?</li> </ul>	<b>11</b>
<b>Software program screen appears but no further operation is possible.</b>	<ul style="list-style-type: none"> <li>• Has the control pad been connected properly?</li> </ul>	<b>8</b>
<b>Picture appears but there is no sound.</b>	<ul style="list-style-type: none"> <li>• Have the player and TV set been connected properly?</li> </ul>	<b>8</b>
	<ul style="list-style-type: none"> <li>• Is the TV set volume at its lowest setting or is it muted?</li> </ul>	—
<b>Something is wrong with the sound.</b>	<ul style="list-style-type: none"> <li>• Has the audio/video cable (if used) been connected properly?</li> </ul>	<b>8</b>
	<ul style="list-style-type: none"> <li>• In the case of a monaural TV set, has the pin-to-pin cable (not supplied) been connected properly?</li> </ul>	<b>9</b>
<b>Poor picture quality.</b>	<ul style="list-style-type: none"> <li>• Have the player and TV set been connected properly?</li> </ul>	<b>8</b>
	<ul style="list-style-type: none"> <li>• Have the TV set's brightness and contrast been adjusted properly?</li> </ul>	—
	<ul style="list-style-type: none"> <li>• Place the player at a distance from the TV set</li> </ul>	—
<b>Edges of the picture are cut off or distorted.</b>	<ul style="list-style-type: none"> <li>• This may occur due to the condition of the TV set and the software, and it is not a malfunction</li> </ul>	—

If the problem persists even though the steps described above have been taken, discontinue use, disconnect the power cord, and consult with a Panasonic service center (In the United States, consult an MSC<sup>®</sup> Authorized Servicer for detailed instructions )

# Specifications

<b>CPU</b>		32-bit RISC processor ARM60 (12.5 MHz)
<b>Memory</b>	<b>RAM/VRAM</b>	3 MB ——— 2 MB Main-RAM   —— 1 MB VRAM
	<b>SRAM</b>	32 KB (Battery back up)
	<b>ROM</b>	1 MB
	<b>DSP</b>	
<b>Video/Audio</b>	<b>Video output</b>	RF Video, NTSC, channel 3 or 4 (Switch selectable) S-Video, NTSC Composite video, NTSC (RS170 A standard)
	<b>Resolution</b>	640 (H) × 480 (V) dots (Inside 320 × 240 dots)
	<b>Colors</b>	Max 16.7 Million/Std 32 k
	<b>Audio</b>	Stereo 16-bit PCM (Sampling 44.1 kHz)
<b>Storage</b>	<b>CD-ROM drive</b>	Size 12 and 8 cm (CD single) Double Speed CD-ROM Drive (Read Buffer 32 KB)
<b>I/O Port</b>	<b>Control port</b>	Low speed I/O Dsub-9 pin × 1 Daisy-chain system
	<b>Expansion port</b>	High speed I/O 30 pin × 1
	<b>AV Expansion port</b>	High speed AV-I/O (Video CD Adaptor) 68 pin × 1
<b>System</b>	<b>System dimensions (W × D × H)</b>	310 × 236 × 68 mm (12.2 × 9.3 × 2.7 inch)
	<b>Weight</b>	1.7 kg (3.8 lbs)
	<b>Power requirement</b>	120 V AC 60 Hz
	<b>Power consumption</b>	30 W
<b>Indicator</b>	<b>Power indicator</b>	Red-LED × 1
	<b>CD-access indicator</b>	Green-LED × 1
<b>Temperature</b>	<b>Operating</b>	10°C to 35°C (50°F to 95°F)
	<b>Storage</b>	-20°C to 60°C (-4°F to 140°F) (When packed for shipment)

Specifications are subject to change without notice

Weight and dimensions are approximate

© Matsushita Electric Industrial Co., Ltd. 1994, All Rights Reserved

## Panasonic

Matsushita Consumer Electronics  
Company, Division of Matsushita  
Electric Corporation of America  
One Panasonic Way Secaucus,  
New Jersey 07094

Panasonic Sales Company,  
Division of Matsushita Electric of  
Puerto Rico, Inc. ("PSC")  
Ave. 65 de Infantería Km. 9.5  
San Gabriel Industrial Park, Carolina,  
Puerto Rico 00985